



# **OPERATION & MAINTENANCE MANUAL**



## **Electronic Tabletop Autoclaves**

### **Models EZ9Plus & EZ11Plus**

*Cat. No. MAN205-0443001EN Rev R-DRAFT*

---

Manufactured by:  Tuttnauer Co. Ltd., Har Tuv Industrial zone B P.O.Box 170, Beit Shemesh 99000, Israel ☎ Tel: 972 2 9904611,  Fax: 972 2 9904730

 Tuttnauer U.S.A. Co, Ltd. 25 Power Drive Hauppauge, NY, 11788, USA. ☎ Tel (631) 737 4850, (800) 624 5836,  Fax: (631) 737 0720

---

## TABLE OF CONTENTS

PARAGRAPH	PAGE NO.
<b>1. GENERAL .....</b>	<b>5</b>
1.1 INCOMING INSPECTION.....	5
1.2 WARRANTY.....	5
1.3 WARRANTY STATEMENT .....	6
<b>2. SAFETY INSTRUCTIONS .....</b>	<b>7</b>
<b>3. GENERAL INFORMATION .....</b>	<b>8</b>
3.1. INTRODUCTION .....	8
3.2. OPERATING CONDITIONS .....	10
3.3. SPECIFICATIONS .....	10
3.4. ELECTRICAL DATA.....	14
3.5. ENVIRONMENTAL EMISSION INFORMATION .....	14
3.6. CONSTRUCTION .....	15
3.7. SYMBOL DESCRIPTION .....	15
3.8. WATER QUALITY.....	16
3.9. DIRECTIVES AND STANDARDS .....	17
<b>3.9.1. Technical Directives.....</b>	<b>17</b>
<b>3.9.2. Technical Standards .....</b>	<b>17</b>
<b>4. CONTROL PANEL.....</b>	<b>22</b>
4.1. DESCRIPTION AND FUNCTIONS OF THE FRONT PANEL.....	22
<b>4.1.1. Visual Information Center.....</b>	<b>23</b>
<b>4.1.2. The Control Center.....</b>	<b>24</b>
<b>4.1.3. Data Center.....</b>	<b>25</b>
4.2. DISPLAYED ERROR MESSAGES / SYMBOLS .....	26
4.3. DISPLAYED OPERATIONAL MESSAGES / SYMBOLS .....	26
<b>5. EZVIEW SCREENS .....</b>	<b>28</b>
5.1. SCREENS SHOWING A SUCCESSFULLY COMPLETED CYCLE.....	28
5.2. SCREENS SHOWING ABORTED CYCLES AFTER A COMPLETED STERILIZATION STAGE .....	29
<b>5.2.1. Canceled by user AFTER complete sterilization stage.....</b>	<b>29</b>
<b>5.2.2. Door is open AFTER the sterilization stage has finished.....</b>	<b>30</b>
<b>5.2.3. Screens showing a High Pressure Failure AFTER a completed sterilization stage.....</b>	<b>30</b>
5.3. SCREENS SHOWING A FAILED CYCLE: .....	31
<b>5.3.1. Screens showing a failure because of a Heat Time Error.....</b>	<b>31</b>
<b>5.3.2. Failure due to Cancellation by user BEFORE completing the sterilization stage</b>	<b>32</b>
<b>6. STERILIZATION PROGRAMS.....</b>	<b>33</b>
6.1. PROGRAM 1: UNWRAPPED INSTRUMENTS .....	35
6.2. PROGRAM 2: WRAPPED INSTRUMENTS, POUCHES.....	36
6.3. PROGRAM 3: UNWRAPPED DELICATE INSTRUMENTS.....	37
6.4. PROGRAM 4: HANDPIECES .....	38

6.5.	PROGRAM 5: CHAMBER BRITE CLEANING .....	39
6.6.	PROGRAM 6: CALIBRATION CYCLE .....	40
6.7.	PROGRAM 7: CUSTOM A (MAY BE ALTERED BY THE USER) .....	41
6.8.	PROGRAM 8: CUSTOM B (MAY BE ALTERED BY THE USER).....	42
<b>7.</b>	<b>CHECKING AND CHANGING PARAMETERS AND OTHER DATA .....</b>	<b>43</b>
7.1.	QUICK OPTIONS DIRECTORY .....	44
7.1.1.	Add extra dry time .....	45
7.1.2.	Export to USB.....	46
7.1.3.	Print cycles.....	49
7.1.4.	Version information .....	50
7.1.5.	Start cycle by clock .....	50
7.1.6.	Set date and time .....	52
7.1.7.	Login.....	53
7.1.8.	Exit .....	54
7.2.	MAIN MENU.....	55
7.2.1.	Cycle Parameters for Custom A and B cycles .....	55
7.2.2.	Modifying a parameter for the Custom A and B cycles .....	57
7.2.3.	System Parameters .....	59
7.2.4.	Maintenance.....	62
7.2.4.1.	Export Gain and Offset to USB.....	63
7.2.4.2.	Reset atmospheric pressure .....	64
7.2.4.3.	Printer Test (for units with an optional printer) .....	65
7.2.4.4.	Print All Gain and Offset (for units with an optional printer) .....	66
7.3.	TABLE OF PARAMETERS .....	67
<b>8.</b>	<b>PRINTER .....</b>	<b>73</b>
8.1.	PRINTER OUTPUT (FOR UNITS WITH OPTIONAL PRINTER) .....	73
8.2.	PRINTER HANDLING (FOR UNITS WITH AN OPTIONAL PRINTER).....	76
8.2.1.	Maintenance.....	76
8.2.2.	Installing printer paper .....	76
8.2.3.	Notes on treatment of thermal papers: .....	78
<b>9.</b>	<b>INSTALLATION INSTRUCTION .....</b>	<b>80</b>
9.1.	LIFTING AND CARRYING.....	80
9.2.	PLACING .....	80
9.3.	ELECTRICAL .....	80
9.4.	SETUP .....	81
9.5.	FILLING THE MINERAL-FREE WATER RESERVOIR. ....	81
<b>10.</b>	<b>PREPARATION BEFORE STERILIZATION .....</b>	<b>85</b>
<b>11.</b>	<b>OPERATING INSTRUCTIONS .....</b>	<b>90</b>
11.1.	TURNING ON THE AUTOCLAVE .....	90
11.2.	PRE-HEATING (EZ11PLUS ONLY) .....	90
11.3.	OPENING THE DOOR.....	91
11.4.	ADDING ADDITIONAL DRYING TIME.....	92
11.5.	LOADING .....	92

---

11.6.	UNLOADING .....	95
11.7.	STOPPING THE PROCESS MANUALLY .....	96
11.8.	STOPPING THE PROCESS DUE TO CYCLE FAILURE .....	97
<b>12.</b>	<b>MAINTENANCE INSTRUCTIONS .....</b>	<b>98</b>
12.1.	PREVENTIVE AND SCHEDULED MAINTENANCE .....	98
<b>12.1.1.</b>	<b>Daily .....</b>	<b>98</b>
<b>12.1.2.</b>	<b>Weekly by the operator .....</b>	<b>98</b>
<b>12.1.3.</b>	<b>Periodically .....</b>	<b>102</b>
12.2.	DRAINING THE RESERVOIR .....	103
12.3.	REPLACING THE DOOR GASKET .....	104
12.4.	CHECKING THE SAFETY VALVE .....	107
12.5.	CLEANING THE WATER OUTLET STRAINER .....	108
12.6.	WATER SENSOR CLEANING .....	110
12.7.	REPLACING THE HEPA AIR FILTER .....	110
<b>13.</b>	<b>TROUBLESHOOTING .....</b>	<b>114</b>
<b>14.</b>	<b>SPARE PARTS LIST .....</b>	<b>121</b>
<b>15.</b>	<b>ACCESSORIES .....</b>	<b>121</b>

**TABLE OF CONTENT (Cont.)**

<b>DRAWINGS</b>	<b>PAGE NO.</b>
<i>FRONT VIEW – EZ9PLUS.....</i>	<i>18</i>
<i>REAR VIEW – EZ9PLUS.....</i>	<i>19</i>
<i>FRONT VIEW – EZ11PLUS.....</i>	<i>20</i>
<i>REAR VIEW – EZ11PLUS.....</i>	<i>21</i>
<i>POUCH RACK AR910 .....</i>	<i>120</i>
<i>TRAY HANDLE CMT240-0097 .....</i>	<i>120</i>
<i>TRAY TRY254-0003 .....</i>	<i>120</i>
<i>TRAY HOLDER TRH411-0021 .....</i>	<i>121</i>

## 1. GENERAL



**Read the Operating Instructions carefully, before beginning any operation on the autoclave!**

### 1.1 Incoming Inspection

Upon receiving your Tuttnauer Autoclave, carefully inspect the outside of the shipping carton for signs of damage. If any damage to the carton is found, note the location with respect to the autoclave and check that area of the autoclave carefully once it is fully unpacked. Observe packing method and retain packing materials until the unit has been inspected. Mechanical inspection involves checking for signs of physical damage such as: scratched panel surfaces, broken knobs, etc.

**If any damage is found, contact your dealer as soon as possible so that they can file a claim with the shipping carrier and also notify Tuttnauer.**

All Tuttnauer products are carefully inspected prior to shipment and all reasonable precautions are taken in preparing them for shipment to assure safe arrival at their destination.

**Note:** Lifting and carrying should always be done by two people.

### 1.2 Warranty

Tuttnauer warrants, from the date of purchase, all new EZPlus autoclaves for a period of two full years, covering both parts and labor.

This two year warranty covers defects in materials and workmanship on every part in the autoclave except door gaskets and HEPA filters (they are considered wear items).

Tuttnauer warrants the chamber for a period of ten (10) years against defects in materials and workmanship.

This warranty does not include installation or operator instruction which are covered in this manual for your convenience or which can be provided by your dealer.

**This warranty does not apply to any instrument that has been subjected to improper use or accident, nor shall it extend to autoclaves that have been repaired or altered outside the factory without prior authorization from Tuttnauer.**

**The warranty also does not include routine cleaning or preventive maintenance, to be performed according to instructions in Sec. 12.1 (Preventive and Scheduled Maintenance).**

Tuttnauer's obligation is limited to the repair or replacement of parts for the autoclave.

No other warranties or obligations are expressed or implied.

**The Autoclave should only be used in a manner described in this manual!**

### **1.3 Warranty Statement**

To activate the warranty, the registration card must be completed and mailed or faxed to Tuttnauer within fourteen (14) days of purchase or you may call our customer service department at the number listed below.

Products will only be received and accepted for repair from an authorized dealer and only with prior return authorization from Tuttnauer. All transportation charges to and from Tuttnauer must be paid by the owner of the autoclave. Tuttnauer will not accept COD shipments. If repairs are needed during the first 90 days after purchase of this autoclave and a local authorized service dealer is not available, Tuttnauer will arrange pick up of the unit at Tuttnauer's expense. This will be on an individually evaluated basis and **ONLY** with pre-approval.

**Note:** If you have any questions or there are any difficulties with this instrument and the solution is not covered in this manual, please contact your dealer or Tuttnauer USA Co. **Do not attempt to service this instrument yourself.**

☒ **Tuttnauer USA** Co., Ltd., 25 Power Drive Hauppauge, NY 11788, USA

☎: (800) 624 5836, (631) 737 4850, ☒Fax: (631) 737 0720  
e-mail:info@tuttnauerUSA.com.

## 2. SAFETY INSTRUCTIONS

The autoclave has unique characteristics. Please read and understand the operation instructions before first operation of the autoclave. This manual includes instructions and guidance provided by the manufacturer: how to operate the autoclave, the door safety mechanism, and the dangers involved in circumventing safety means, how to ensure that the door is closed, and how to select a correct sterilization program.

Make sure that you know where the main power switch is located.

Autoclave maintenance is crucial for the correct and efficient function of the device.

Never use the autoclave to sterilize corrosive products, such as: acids, bases and phenols, volatile compounds or solutions such as ethanol, methanol, chloroform or radioactive substances.

Below are the operating instructions – safety instructions:

1. All autoclave users must receive training in proper usage from an experienced employee. Every new employee must undergo a training period under an experienced employee.
2. When sterilizing plastic materials, refer to the item manufacture information and make sure that the item can withstand the sterilization temperature. Plastic that melts in the chamber is liable to cause a great deal of damage.
3. On closing the device door, make sure it is properly locked before activating. Verify that the **DOOR OPEN**  symbol is replaced by **“System Ready”**.
4. When withdrawing trays, use the enclosed tray handle or wear heat resistant gloves.
5. The door is electronically locked and will not open unless the pressure in the chamber equals the atmospheric pressure (chamber pressure is displayed on the screen).
6. The door also remains locked if there is a cycle failure or the unit has no power.
7. Open the door slowly to allow steam to escape.
8. Once a month, ensure that the safety valve is operating, and once every 5 years a certified inspector must perform a chamber pressure safety test.
9. Make sure there are no leaks, breaks, blockages, whistles or strange noises.
10. Perform maintenance operations as instructed. The owner of the autoclave is responsible to perform the maintenance operations.
11. Notify the person in charge immediately of any deviation from the proper function of the device.
12. Protective equipment and clothes and other safety instructions should be implemented in accordance with local and national regulations and/or rules!



### 3. GENERAL INFORMATION

#### 3.1. Introduction

The EZPlus tabletop autoclave is designed for sterilization of wrapped and unwrapped instruments, and related items found in dental, medical, and veterinary clinics, first aid rooms, hospitals, laboratories etc.

This autoclave is an electrically – heated sterilizer using steam as the sterilizing agent. This unit uses steam flush pressure pulse technology for removing air from the chamber. A computerized control unit ensures a fully automatic sterilization cycle, control and monitoring of physical parameters and a clear documentation of the sterilization cycle.

The autoclave offers a choice of four automatic programs and two custom programs designed to match the material to be sterilized. In addition there is a dedicated cleaning program. The autoclave is equipped with an Air Assisted Drying system. This includes an air pump that during the drying stage draws air through a HEPA filter (0.2µm) and circulates that air through the heated chamber to remove moisture and facilitate the drying operation. **Drying is performed with the door closed.**

On all models, a water pump is installed between the water reservoir and the chamber. This pump guarantees fast and accurate filling of the chamber every time. Entry of water may be accompanied by a noise for approximately 30 seconds. This is normal noise generated by the regular operation of the pump.

The EZPlus series features a digital absolute pressure display for monitoring and control purposes. The pressure display indicates if there is pressure in the chamber. The device is capable of displaying the pressure in psia, psig, or in kPa according to the operator's requirements. When the pressure is displayed in psig, the atmospheric pressure is shown (at sea level) as 0 psig. If the pressure is defined in psia or kPa the absolute zero is displayed as "0" and the atmospheric pressure is shown (at sea level) as 14.7 psia or 100 kPa respectively.

**Note:** This unit comes from the factory with the pressure parameter set to display in psig.

The EZPlus can display temperature in °F or °C.

**Note:** The unit comes from the factory set to display temperature in °F.

---

The control system is designed to meet the most current sterilization standards to ensure efficacy, safety of personnel and reliable operation. See sec. 3.9

A printer is an optional addition to the autoclave. The printer prints the preset and actual parameters of the cycle (temperature, time and pressure).

The EZPlus features built in memory to record up to 100 sterilization cycles. These can be reprinted on the optional printer or exported to a USB device to be transferred to a PC.

The EZPlus has a built in Network Port for use with Tuttnauer's R.PC.R software when connected to your local network.

The R.PC.R software has been developed especially for the Tuttnauer autoclaves.

This application will allow you to:

- Monitor up to 8 autoclaves
- Monitor the real time activity of any autoclave connected via the network port.
- Manage the history files of the cycles run on your autoclave. The history files can be downloaded either directly through a physical connection to the network port or transferred manually using a USB device.
- Store all the history of the processes that have been run on your autoclave
- Track the parameter setting that have been used in each of the cycles and stages run.
- Choose the style of the report to view; either graph, table, or a print out
- All reports can be saved as a PDF.
- The graph style report offers the user an option to customize the inputs and outputs used in the presentation.

For more information on the R.PC.R refer to the R.PC.R user guide.

This manual is intended for the user and gives the user a general understanding of the instrument and the best ways to operate and take care of it in order to obtain effective results.

Before operating this autoclave read carefully this operation manual. After reading this manual, operating the autoclave will be easy. However since this instrument is built with high technology sensitive components, no attempt should be made by the user or any other unauthorized person to repair or recalibrate it.



Only technical personnel, of an authorized Tuttnauer dealer, having proper qualifications and holding technical documentation (including a technician manual) and adequate information are authorized to service the apparatus.

### 3.2. Operating Conditions

This device is for indoor use only!

The minimum counter depth for the EZ9Plus and EZ11Plus is 22 inches.

Counter tops or slide-outs need to have a minimum capacity of 175 pounds for the EZ9Plus and 190 pounds for the EZ11Plus.

The sterilizer should be loaded only with autoclavable material!

Minimum room ventilation shall be 10 cycles per hour

The environment shall not exceed an ambient temperature range of from 41°F (5°C) to 104°F (40°C) and a relative humidity of 85%

The operational altitude shall not be over 6562 feet (2000 meters) (ambient pressure shall not be lower than 11.6 psia (80 kPa)).

Operate the autoclave only in the manner specified in the manual. If the equipment is used in a manner not specified by the manufacturer, the protection provided by the equipment may be impaired.



#### CAUTION!

Waste water should be brought into the public net in accordance with the local rules or requirements  
**ONLY NON-HAZARDOUS LIQUIDS SHALL BE DISPOSED IN PUBLIC SEWAGE!**

### 3.3. Specifications

Property		Value	
		9"	11"
Chamber	Dia.	9" (230 mm)	11" (280 mm)
	Depth	19.8" (504 mm)	19.8" (504 mm)
Chamber volume		5.2 gal (19.8 lit)	7.5 gal. (28.5 lit)
External dimensions	Width	19.1" (485 mm)	20.9" (530 mm)
	Height	15.1" (384 mm)	17.3" (440 mm)
	Depth	24.8" (630 mm)	24.8" (630 mm)
Maximum dimensions (door open)		36.2" (920 mm)	37.8" (960 mm)

Property		Value	
		9"	11"
Distance between supporting legs	Between front and rear legs	16.3" (415 mm)	16.3" (415 mm)
	Front legs	10.5" (266 mm)	12.4" (315 mm)
	Rear legs	13.8" (351 mm)	15.7" (400 mm)
Weight		94 lbs. (43 kg)	110 lbs. (50 kg)
Weight w/max solid load and full reservoir		114.6 lbs. (52 kg)	136 lbs. (62 kg)
Shipping weight		106 lbs. (48 kg)	126lbs. (57 kg)
Weight per support area (max. load)		Counter tops or slide-outs need to have a minimum capacity of 175 pounds for the EZ9Plus and 190 pounds for the EZ11Plus.	
Minimum counter depth		22 inches	22 inches
Shipping dimensions	Width	25" (63.5cm)	25.5" (64.7 cm)
	Height	19" (48cm)	22" (55cm)
	Depth	29" (75 cm)	29" (75 cm)
	Volume	7.97 ft <sup>3</sup> (0.23 m <sup>3</sup> )	9.4 ft <sup>3</sup> (0.267 m <sup>3</sup> )
Mineral-free water reservoir	Max. water volume	1.375 US gal (5.2 lit.)	
	Min. water volume	0.4 US gal (1.5 lit.)	
Maximum solid load per item		1.1 lbs. (0.5 kg)	1.1 lbs. (0.5 kg)
Maximum solid load per tray		3.0 lbs (1.4 kg)	3.0 lbs (1.4 kg)
Maximum solid load		9.0 lbs (4.1 kg)	15 lbs (6.8 kg)
Maximum textile load		1.5lbs (0.7kg)	1.7lbs (0.8)
Tray dimensions	W	6.7" (169 mm)	6.7" (169 mm)
	H	0.6" (16 mm)	0.6" (16 mm)
	D	16.3" (413 mm)	16.3" (413mm)
Max. Allowable Working pressure (MAWP)		40 psi (2.8 bar)	
No. of trays		3	5
Cassette capacity based on 8"x11" and 8"x 5.5" Miltex Thompson cassettes		2 full & 2 half Loaded horizontally	4 full & 4 half Loaded vertically

**Overall Dimensions – EZ9Plus**

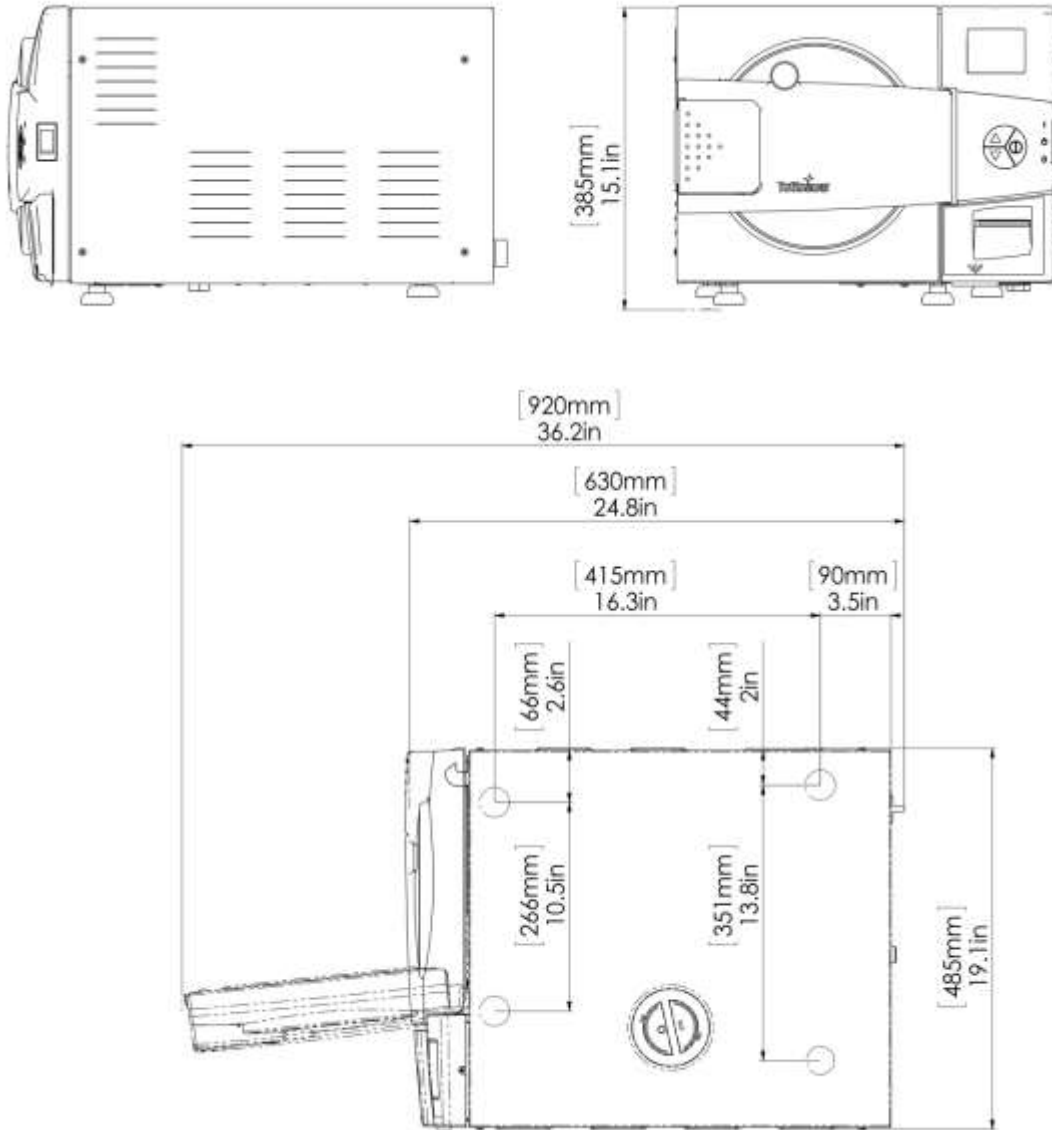

**Overall Dimensions – EZ11Plus**

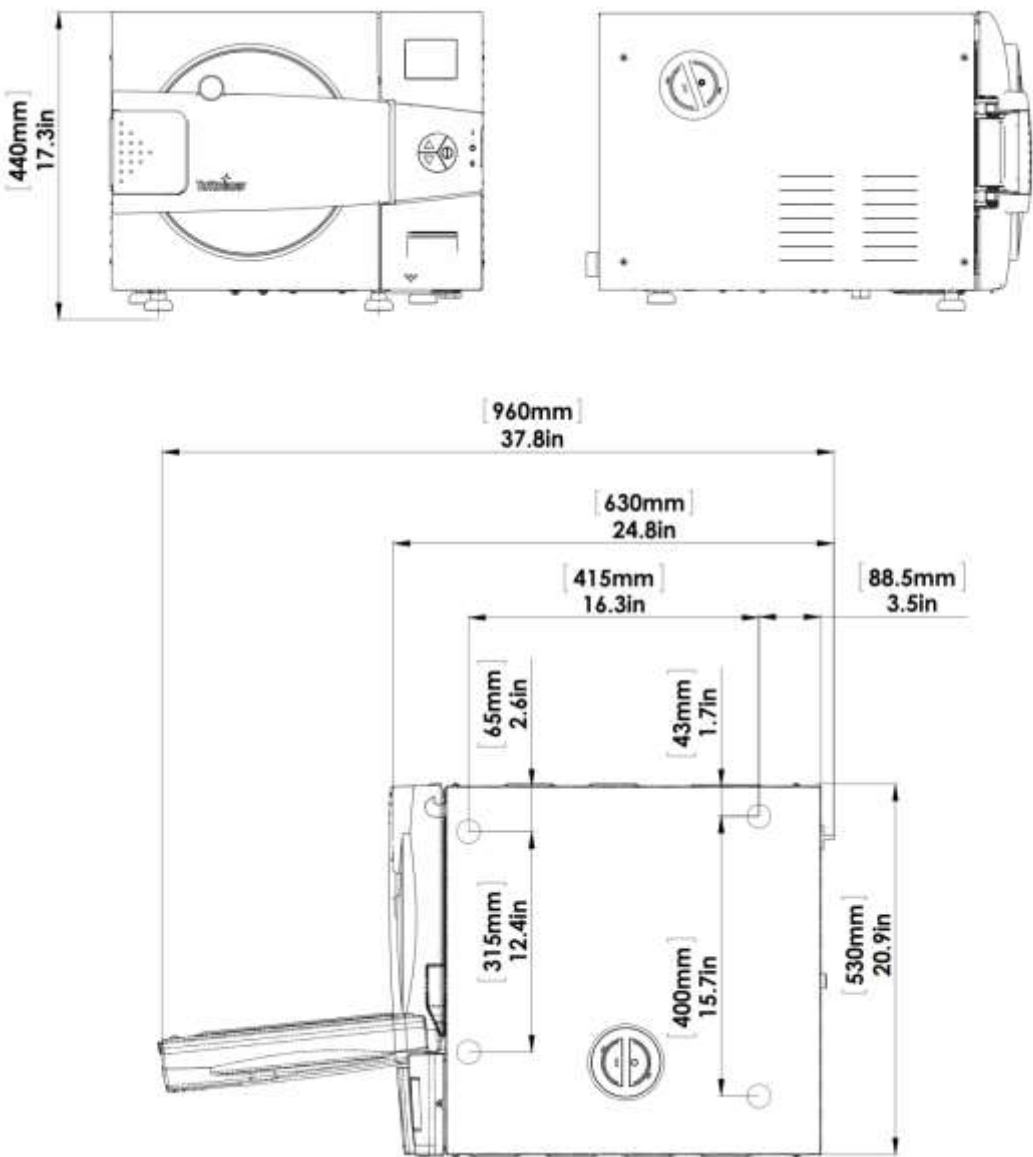

### 3.4. Electrical Data

Model / Specifications	9"	11"
	EZ	EZ
Total Power	1400W	1400W
Voltage	120VAC $\pm$ 5%, 60Hz / 1 ph*	120VAC $\pm$ 5%, 60Hz / 1 ph*
Amperage	12A	12A
Recommended circuit breaker	15A	15A
Protection against electrical shock	Class I (IEC 60601-1) (GFCI)	
Mains supply fluctuation	+/- 5%	
Degree of protection by enclosure	IP31	
Electrical Circuit	Dedicated electrical circuit	

\* According to the local network.



**Note:**

In order to avoid any injury by electrical hazard, it is recommended that a ground fault protection device (GFCI) be installed in the electrical panel feeding the autoclave (local codes may make this mandatory).



**Attention:**

- The electrical net must be protected with a current leakage safety relay (GFCI).
- The electrical network must comply with local rules or regulations.
- Verify that there is an easy access to the main power switch and to the current leakage safety relay (GFCI).
- Surge protection is recommended in areas that experience large voltage or ground fluctuations.
- It is recommended that the autoclave be installed on a dedicated line.

### 3.5. Environmental Emission Information

1. The peak sound level generated by the autoclave is 65dBa with background noise of 48 dBa.
2. The total heat per hour transmitted by the autoclave is <200Wh.

### 3.6. **Construction**

The main parts of the autoclave are made of materials as indicated below:

- Chamber is built of stainless steel 316 L.
- Door is made of stainless steel 304.
- Trays are made of stainless steel 304.
- Water reservoir is made of polyethylene.
- Door handle and door cover are made of hard plastic material, which is safe to touch and thermo-insulated.

### 3.7. **Symbol Description**



Caution! Consult accompanying documents



Caution! Hot surface.



Caution! Hot steam.



Protective earth (Ground)



### 3.8. Water Quality

#### **Physical characteristics and contaminants levels**

The distilled or mineral – free water supplied to the autoclave should have the physical characteristics and maximum acceptable level of contaminants indicated in the table below:

<b>Physical Characteristics and Maximum acceptable contaminants levels in steam for sterilizers (According to EN 13060:2004).</b>	
<b>Element</b>	<b>Condensate – allowable content</b>
Silicon dioxide SiO <sub>2</sub>	≤0.1 mg/kg
Iron	≤0.1 mg/kg
Cadmium	≤0.005 mg/kg
Lead	≤ 0.05 mg/kg
All other metals except iron, cadmium, lead	≤0.1 mg/kg
Chloride (Cl)	≤0.1 mg/kg
Phosphate (P <sub>2</sub> O <sub>5</sub> )	≤0.1 mg/kg
Conductivity (at 20°C)	≤3 µs/cm
pH value (degree of acidity)	5 to 7
Appearance	Colorless clean without sediment
Hardness (Σ Ions of alkaline earth)	≤0.02 mmol/l

**Compliance with the above data should be verified by testing in accordance with acknowledged analytical methods, by an authorized laboratory.**



**Attention:**

**We recommend testing the water quality once a month. The use of water for autoclaves that does not comply with the table above may have severe impact on the working life of the sterilizer and can invalidate the manufacturer's guarantee.**

### **3.9. Directives and Standards**

Every autoclave meets the provisions of the following Directives and is in compliance with the following Standards:

#### **3.9.1. Technical Directives**

- Medical Device Directive 93/42/EEC
- Pressure Equipment Directive 97/23/EEC

#### **3.9.2. Technical Standards**

USA Standards:

- ANSI/AAMI ST55:2010
- ASME Sec. VIII. Div 1
- UL 61010-1
- UL 61010-2-040
- FDA 510(K) Cleared
- ISO 17665-1:2006
- The Quality System complies with ISO 13485:2003 and ISO 9001:2008

Canada Standards: CMDR

**FRONT VIEW – EZ9Plus**

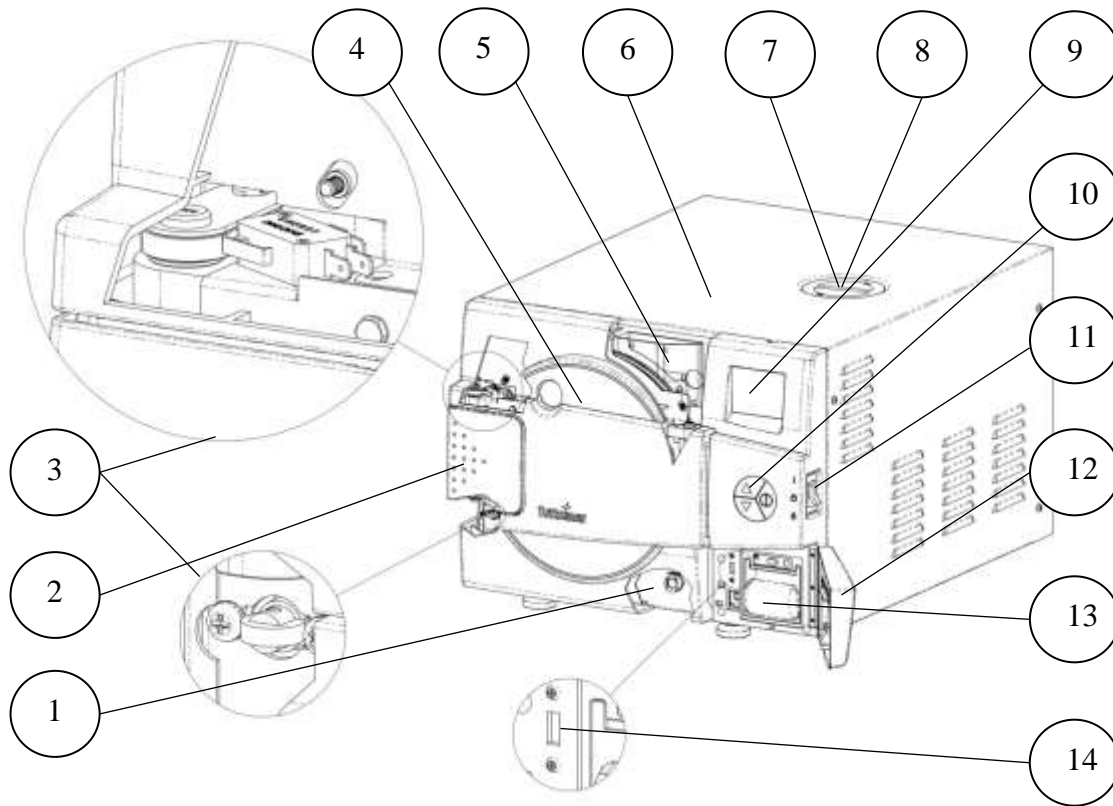

No.	Description	No.	Description
1	Reservoir drain	8	Safety valve
2	Door opening grip	9	EZView display
3	Door micro-switches	10	EZPad keypad
4	Door cover	11	Autoclave On/Off switch & circuit breaker
5	Water reservoir fill & level gauge	12	Printer cover
6	Autoclave cover	13	Printer (optional)
7	Mineral-free water reservoir cover	14	USB port

**REAR VIEW – EZ9Plus**

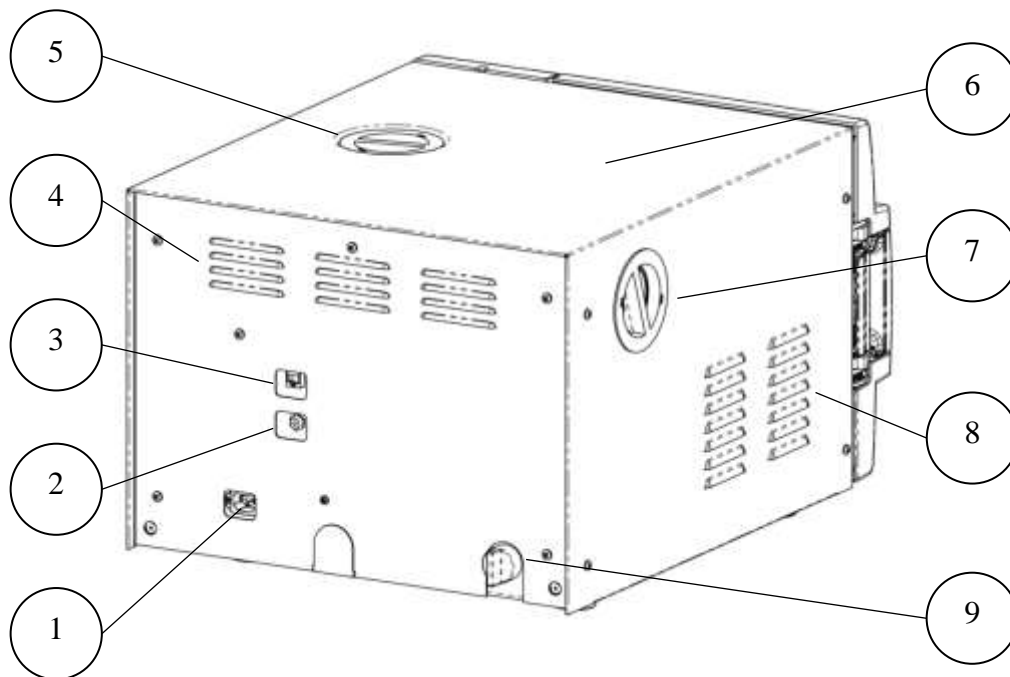

No.	Description
1	Main power electric cable socket
2	Cut-off thermostat
3	Network port
4	Ventilation grills
5	Mineral-free water reservoir cover
6	Autoclave cover
7	HEPA filter cover
8	Ventilation grills
9	Water outlet strainer

**FRONT VIEW – EZ11Plus**

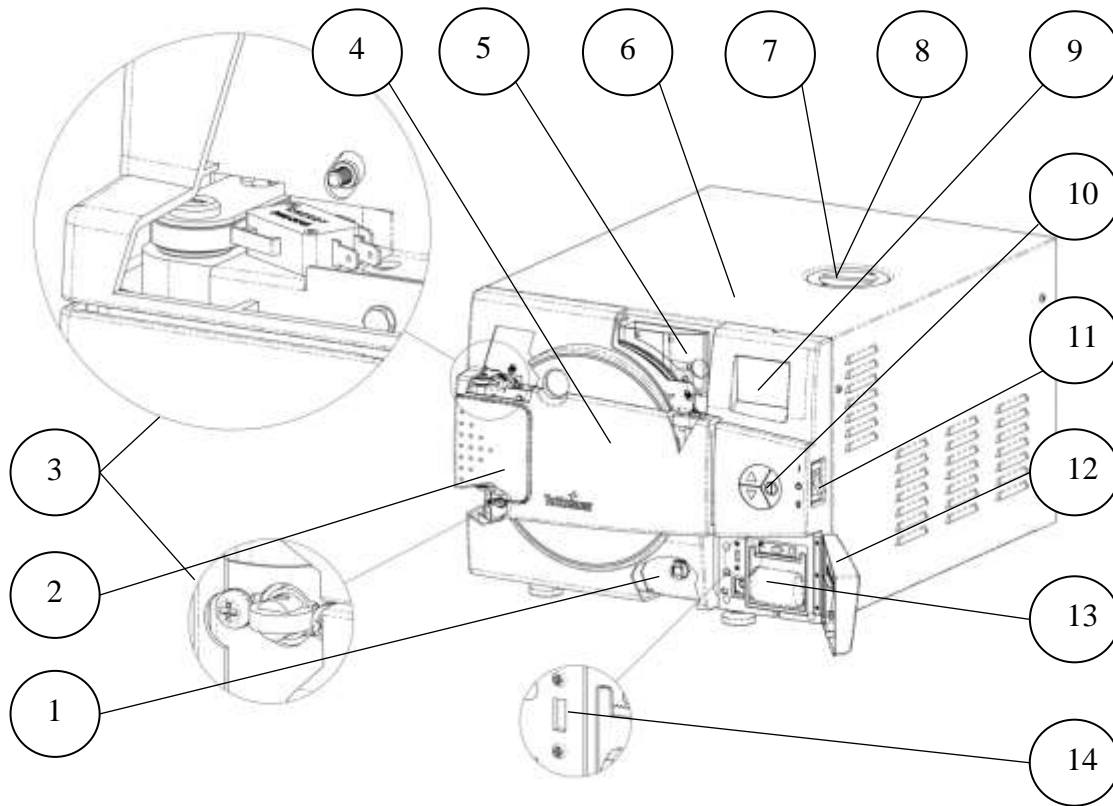

No.	Description	No.	Description
1	Reservoir drain	8	Safety valve
2	Door opening grip	9	EZView display
3	Door microswitches	10	EZPad keypad
4	Door cover	11	Autoclave On/Off Switch & circuit breaker
5	Water reservoir fill & level gauge	12	Printer cover
6	Autoclave cover	13	Printer (optional)
7	Mineral-free water reservoir cover	14	USB port

**REAR VIEW – EZ11Plus**

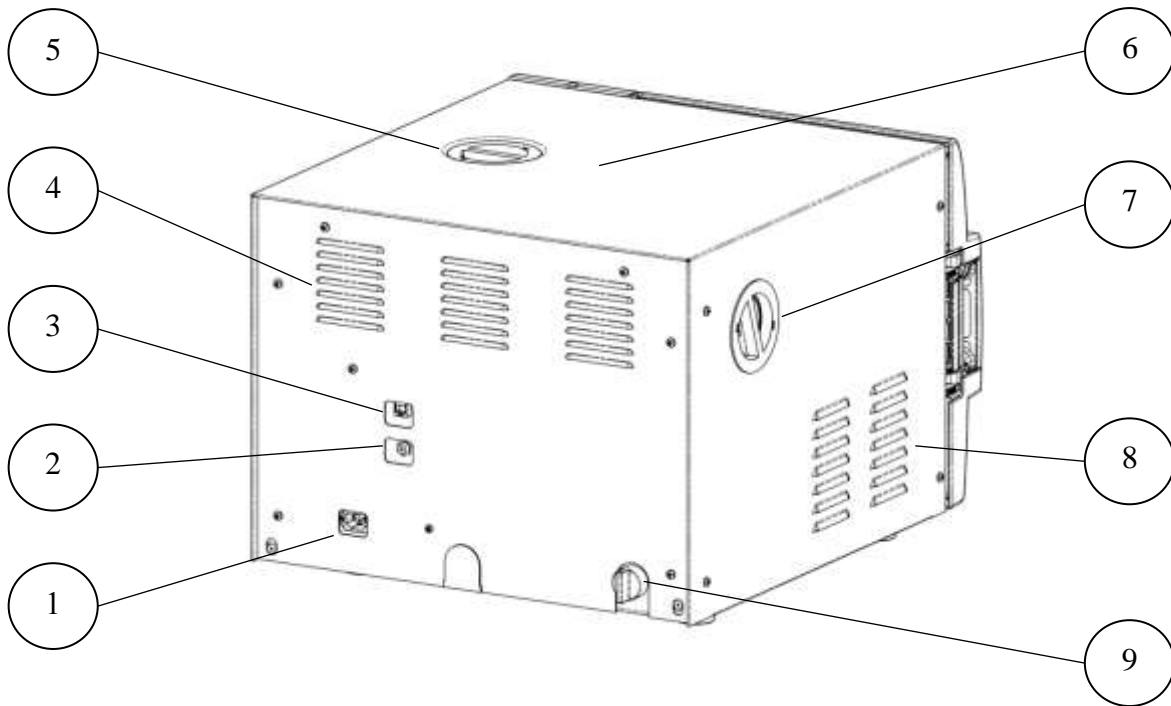

No.	Description
1	Main power electric cable socket
2	Cut-off thermostat
3	Network port
4	Ventilation grills
5	Mineral-free water reservoir cover
6	Autoclave cover
7	HEPA filter cover
8	Ventilation grills
9	Water outlet strainer

## 4. CONTROL PANEL

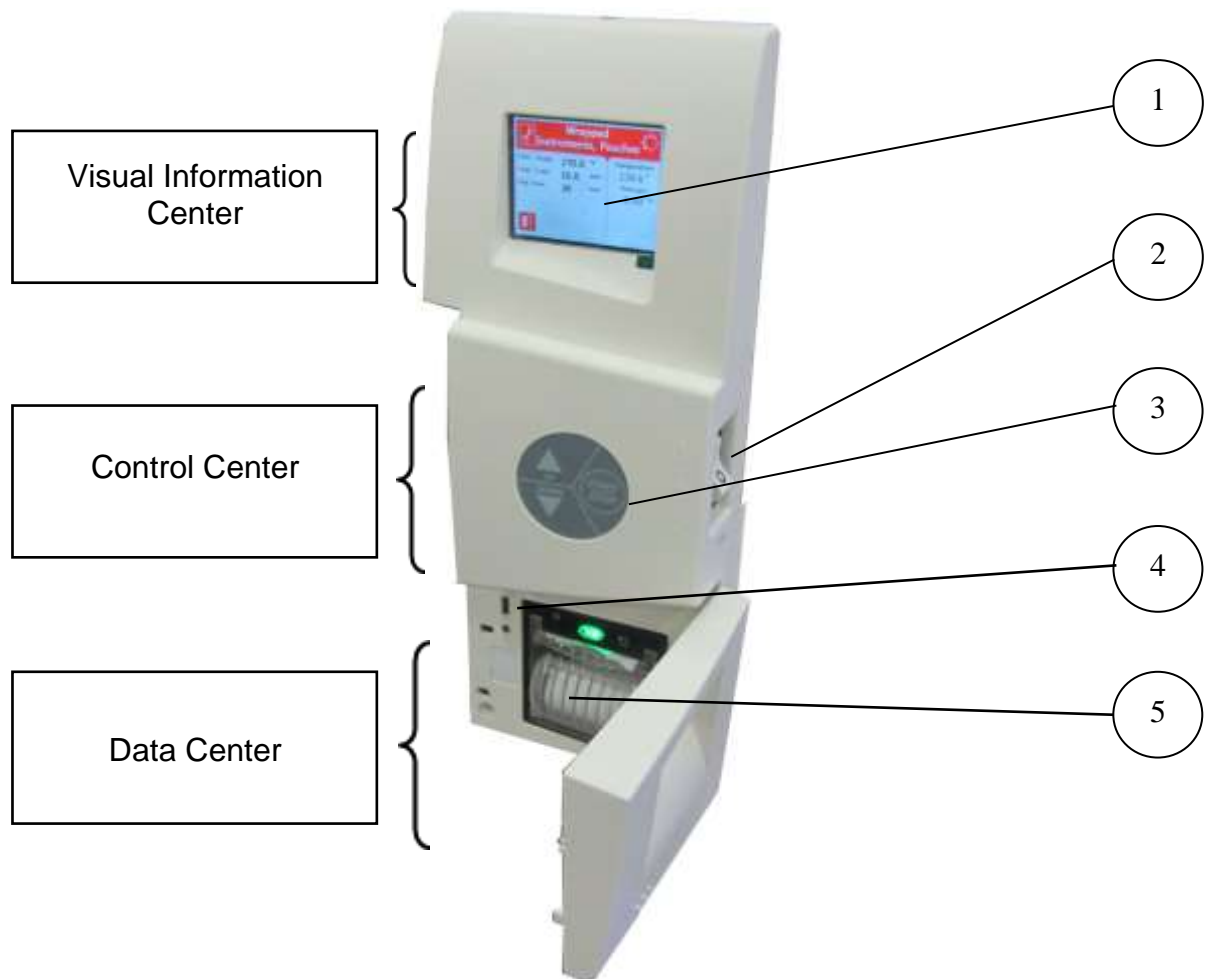

No.	Description
1	EZView display
2	Main switch and circuit breaker
3	EZPad keypad
4	USB port
5	Printer (optional)

### 4.1. Description and Functions of the Front Panel

The front panel is composed of 3 sections (see picture on previous page):

1. Visual Information Center
2. Control Center.
3. Data Center

### 4.1.1. Visual Information Center

The information center contains the EZView display which is an LCD panel used to display the current status of the autoclave and any Operational Messages or Error Messages.

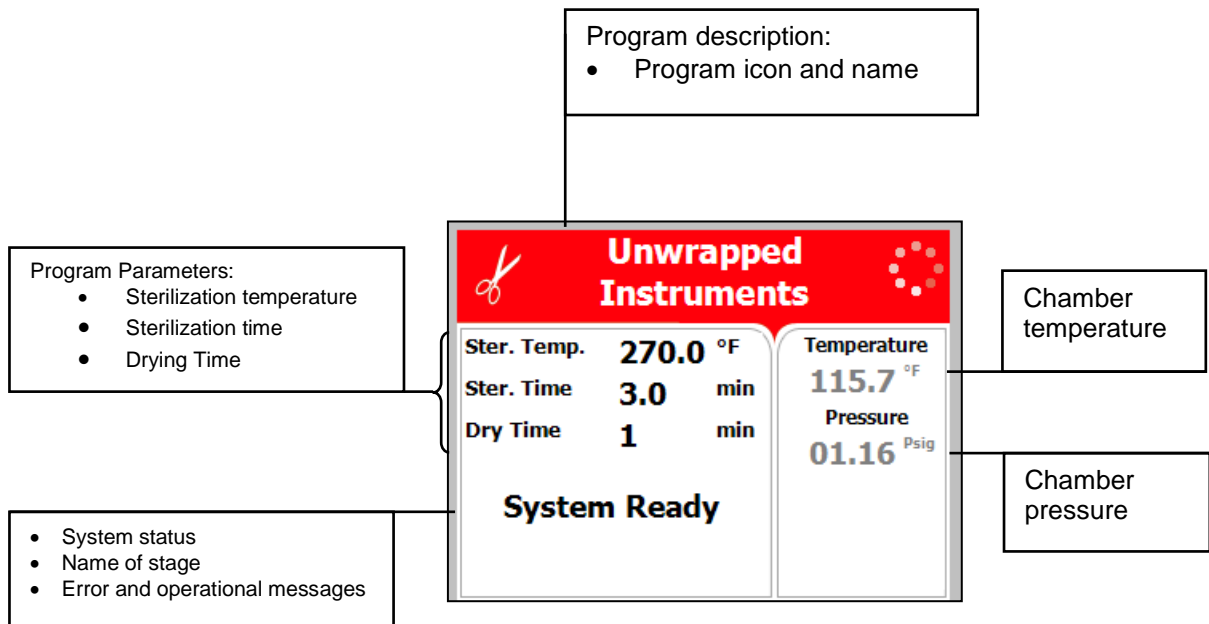





### 4.1.2. The Control Center

The Control Center contains the ON/OFF switch/Circuit Breaker and the EZPad keypad.

The keypad consists of 3 keys as described below:

<p><b>UP key</b> This key has the following functions:</p> <ul style="list-style-type: none"> <li>• In the main screen: <ul style="list-style-type: none"> <li>○ This key enables the operator to browse through the cycles.</li> </ul> </li> <li>• In the menu directories: <ul style="list-style-type: none"> <li>○ When the cursor is blinking on a number, the <b>UP ▲</b> key increases its value.</li> <li>○ When the cursor is blinking on a menu selection, the <b>UP ▲</b> key allows browsing backward through the menu.</li> <li>○ When adjusting a parameter and the cursor is blinking on <b>SET</b> or <b>EXIT</b> the <b>UP ▲</b> key activates that procedure.</li> </ul> </li> </ul>	
<p><b>DOWN key</b> This key has the following functions:</p> <ul style="list-style-type: none"> <li>• In the main screen: <ul style="list-style-type: none"> <li>○ This key enables the operator to browse through the cycles.</li> </ul> </li> <li>• In the menu directories: <ul style="list-style-type: none"> <li>○ When the cursor is blinking on a number, the <b>DOWN ▼</b> key decreases its value.</li> <li>○ When the cursor is blinking on a menu selection, the <b>DOWN ▼</b> key allows browsing forward through the menu. When adjusting a parameter and the cursor is blinking on <b>SET</b> or <b>EXIT</b> the <b>DOWN ▼</b> key activates that procedure.</li> </ul> </li> </ul>	
<p><b>START/STOP key</b> This key has the following functions:</p> <ul style="list-style-type: none"> <li>• In the main screen: <ul style="list-style-type: none"> <li>○ Starts the process when the required program was chosen.</li> <li>○ Stops the current process.</li> <li>○ Cancels the ERROR message displayed on the screen and opens the electric door lock.</li> </ul> </li> <li>• In the menu directories: <ul style="list-style-type: none"> <li>○ When the cursor is blinking on a number, the <b>START/STOP</b> key enables moving to the next position.</li> <li>○ When the cursor is blinking on a menu selection, the <b>START/STOP</b> key activates that selection.</li> </ul> </li> </ul>	

### **4.1.3. Data Center**

The Data Center contains a USB port, a network port and an optional printer.

- The USB port can be used to upload or download software and settings and download cycle history for transferring to a PC for storage or printing.
- The network port (located on the rear of the unit) can be used to connect to a local network and download information to Tuttnauer's R.PC.R software.

The RPCR software has been developed especially for the Tuttnauer autoclaves and is an excellent report generating tool.

This software will allow you to:

- Monitor up to 8 autoclaves
- Monitor the real time activity of any autoclave connected via the network port.
- Manage the history files of the cycles run on your autoclave. The history files can be downloaded either directly through a physical connection to the network port or transferred manually using a USB device.
- Store all the history of the processes that have been run on your autoclave
- Track the parameter settings that have been used in each of the cycles and stages run.
- Choose the style of the report to view; either graph, table, or a print out
- All reports can be saved as a PDF.
- The graph style report offers the user an option to customize the inputs and outputs used in the presentation.

For more information on the R.PC.R refer to the R.PC.R user guide.

- The printer is an optional device. It prints the detailed history of each cycle performed by the autoclave. The printing is on thermal paper with 24 characters per line and records the sterilization cycle information for subsequent consideration.

#### 4.2. Displayed Error Messages / Symbols





An error message is displayed when a failure occurs. The failures are divided into two categories.

1. Failures that occur before completing the sterilization stage, which in this case will leave the load unsterilized
2. Failures that occur after completing the sterilization stage, which in this case will leave the load sterilized

For the list of *Displayed Error Messages / Symbols* see sec. 13 TROUBLESHOOTING

#### 4.3. Displayed operational messages / symbols

Operational messages tell you the status of the machine before or after a cycle.

Message / Symbol Name	Message / Symbol Description	Required Action
	This symbol is displayed when the door is open.	Close the door.
"Door is open"	This message is displayed in stand-by when the door is opened and the START/STOP key is pressed.	Close the door to perform a new cycle. If the problem persists, call the technician.
	This message is displayed if the electrode in the chamber senses water.	DO NOT open the door, water will spill out. Run a new cycle to drain the chamber.
	This symbol is displayed when there is no water in the mineral-free water reservoir.	Pour water in the front funnel until it reaches the full level.
"Cycle Ended"	This message is displayed when the cycle has ended successfully.	Open the door. The Instruments are ready to be removed.
	This symbol is displayed when Cycle by Clock mode is active.	Enter the Quick Options menu as described in this manual to change the time or to cancel this option.
"Start cycle by clock is active"	This message is displayed if the user presses START/STOP key while the "start cycle by clock" mode is active. Starting another cycle is not allowed.	Enter the Quick Options menu as described in this manual to change the time or to cancel this option.

<p>"Atmospheric pressure not set"</p>	<p>This message is displayed when the ATM needs to be set.</p>	<p>Opening the door for 2 minutes will allow the Atmospheric pressure to be set automatically.</p>
<p>"Please restart machine in order for changes to be updated"</p>	<p>Changes to the system software require that the autoclave be restarted.</p>	<p>Restart the autoclave in order for changes to be updated.</p>

## 5. EZView SCREENS

During the cycle the EZView screen will change to let you know how the cycle is progressing. The following screens are a representation of what will be seen during a cycle.

### 5.1. Screens showing a successfully completed cycle

#### 1. System Ready



#### 2. Pre-heating

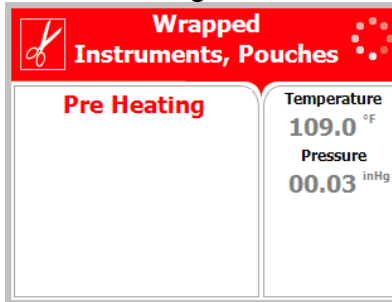

#### 3. Starting



#### 4. Water Filling

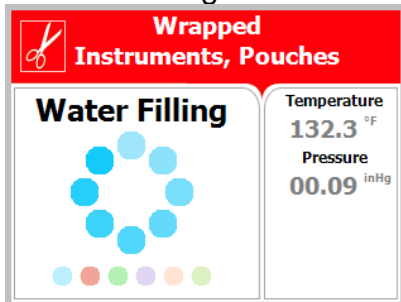

#### 5. Steam Flush



#### 6. Pulse L

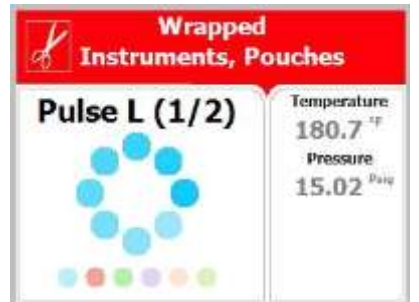

#### 7. Pulse H

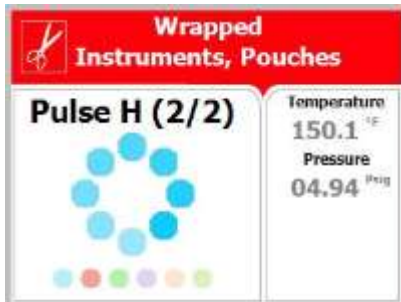

#### 8. Heating

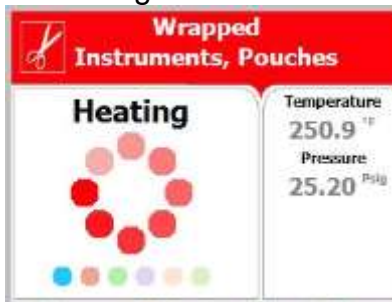

#### 9. Sterilization



#### 10. Exhaust

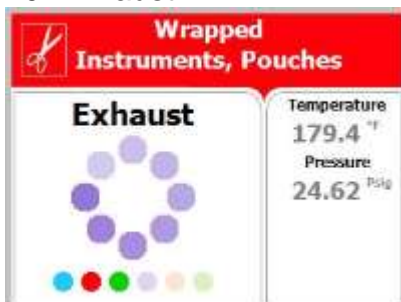

#### 11. Drying



#### 12. Ending



13. Cycle Ended (successful cycle)

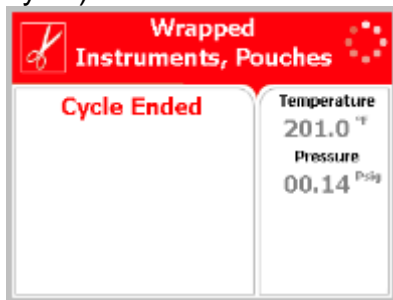

**5.2. Screens showing aborted cycles AFTER a completed sterilization stage**

The sterilization phase ended successfully – the cycle was aborted and the reason for the failure is displayed. When the sterilization portion of the cycle is successful the EZView display remains white even though the cycle was aborted.

**Note:** There is a mandatory 1 minute of drying at the end of any aborted cycle.

The next three scenarios show examples of possible error messages:

**5.2.1. Canceled by user AFTER complete sterilization stage**

The sterilization stage ended successfully, however the operator manually aborted the remainder of the cycle, by pressing the **START/STOP** key. This resulted in the following sequence of screens showing the reason for the aborted cycle.



**Note:** The user will have to press the **START/STOP** key, after the mandatory 1 minute drying, to clear the message and unlock the door.

**5.2.2. Door is open AFTER the sterilization stage has finished**

The sterilization stage ended successfully, however the door switch indicated that the door was opened. This resulted in the following sequence of screens showing the reason for the aborted cycle.

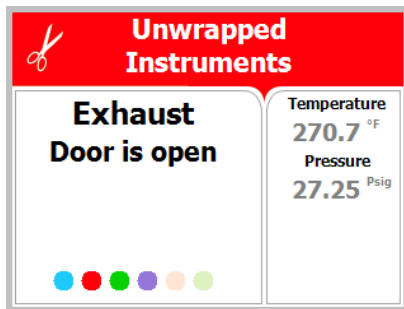

**Note:** The user will have to press the **START/STOP** key, after the mandatory 1 minute drying, to clear the message and unlock the door.

**5.2.3. Screens showing a High Pressure Failure AFTER a completed sterilization stage**

The sterilization stage ended successfully, however the chamber indicated that there was high pressure during the exhaust phase. This resulted in the following sequence of screens showing the reason for the aborted cycle.

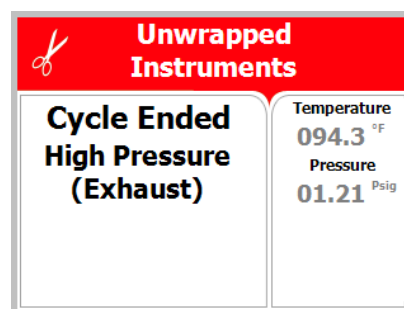

**Note:** The user will have to press the **START/STOP** key, after the mandatory 1 minute drying, to clear the message and unlock the door.

### 5.3. Screens showing a failed cycle:

When the machine fails **BEFORE** the sterilization phase is completed the EZView display becomes yellow, a warning sign  and the reason for the failure will appear.

**Note:** There is a mandatory 1 minute of drying at the end of any aborted cycle.

An explanation of how the EZView display screen will look when a cycle has failed:

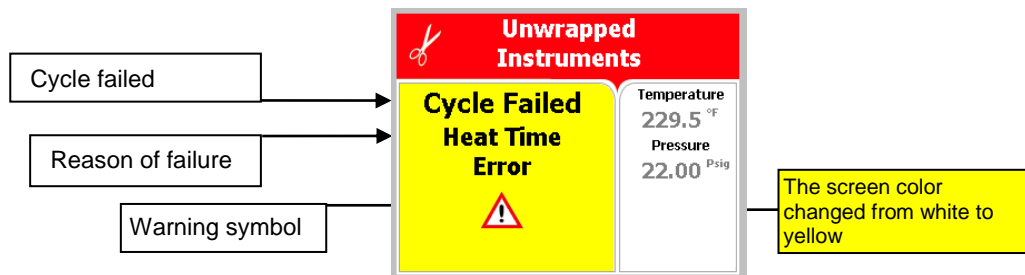

The next two scenarios show examples of possible error messages:

#### 5.3.1. Screens showing a failure because of a Heat Time Error

The machine was not able reach the proper temperature. This resulted in the following sequence of screens showing the reason for the aborted cycle.

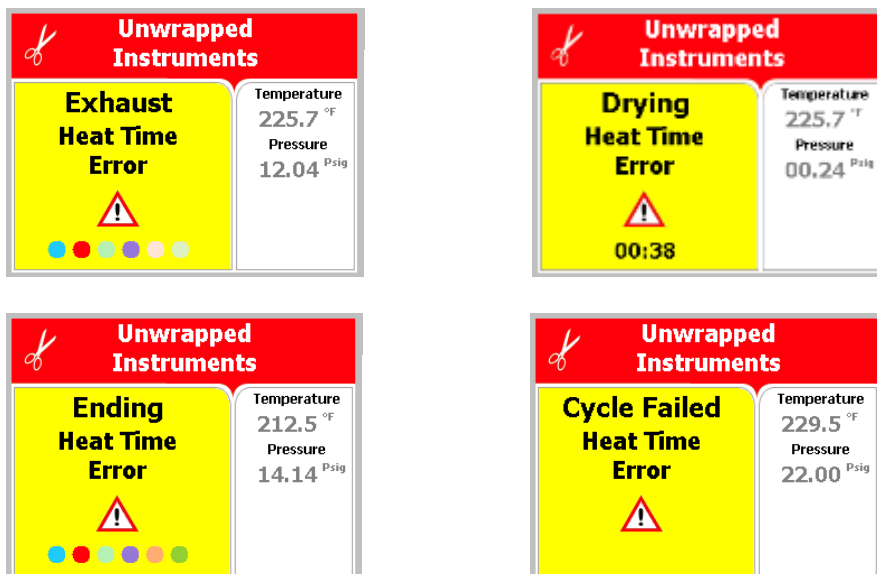

**Note:** The user will have to press the **START/STOP** key, after the mandatory 1 minute drying, to clear the message and unlock the door.



**5.3.2. Failure due to Cancellation by user BEFORE completing the sterilization stage**

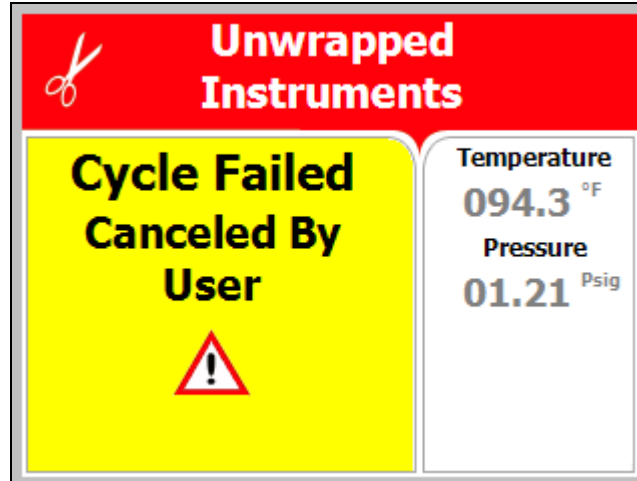

**Note:** The user will have to press the **START/STOP** key, after the mandatory 1 minute drying, to clear the message and unlock the door.

## 6. STERILIZATION PROGRAMS

The control system incorporates a safety feature that prevents changing programs if the door is closed.

This protection is intended to prevent running an inappropriate program if the autoclave is loaded, but the cycle is not immediately started.







If the operator for example inserts the load into the chamber, closes the door and leaves the room and another operator/user tries to change the program, the operator/user will not be able to do this unless the door is opened and the type of load inside the chamber can be seen.





The autoclave offers four preset FDA cleared sterilization programs, a dedicated cleaning program (for cleaning the chamber using Chamber Brite), a calibration program (for use by a technician) and two custom programs. The custom programs are not FDA cleared and it is the user's responsibility to validate these programs.

**Spore testing is your only assurance of complete sterilization.**

Using the **UP OR DOWN** keys enables the user to select the various programs as seen in the following list:

Sterilization Programs			Temp	Sterilization time (minutes)	Dry time (minutes)
Program	Icon	Description			
1		Unwrapped Instruments	270°F (132°C)	3	1 (default) Range: 1-99
2		Wrapped Instruments, Pouches	270°F (132°C)	4	30 (default) Range: 30-99
3		Unwrapped Delicate Instruments	250°F (121°C)	30	1 (default) Range: 1-99
4		Handpieces	270°F (132°C)	4	30 (default) Range: 30-99
5		Chamber Brite Cleaning	270°F (132°C)	3 Keep temperature	0 (default)
6		Calibration cycle	270°F (132°C)	15	1

7		Custom A	270°F (132°C)	4	30 (default) Range: 0-99
8		Custom B	250°F (121°C)	30	1 (default) Range: 0-99

During the process, the various stages of the cycle will be displayed on the screen, as shown in this example and in sec. 5.1.

The stages names are as follows:

- Starting
- Water Filling
- Steam Flush
- Pulse H
- Pulse L
- Heating
- Sterilization
- Exhaust
- Drying
- Ending





**Unwrapped  
Instruments**

**Sterilization**



**02:53**

Temperature  
**270.5** °F

Pressure  
**28.24** Psig



**The user should use only those sterilizer accessories (Biological Indicators, Chemical Indicators. Etc.) that have been cleared by the FDA for the specific cycle time and temperature of this device.**

### 6.1. Program 1: Unwrapped Instruments

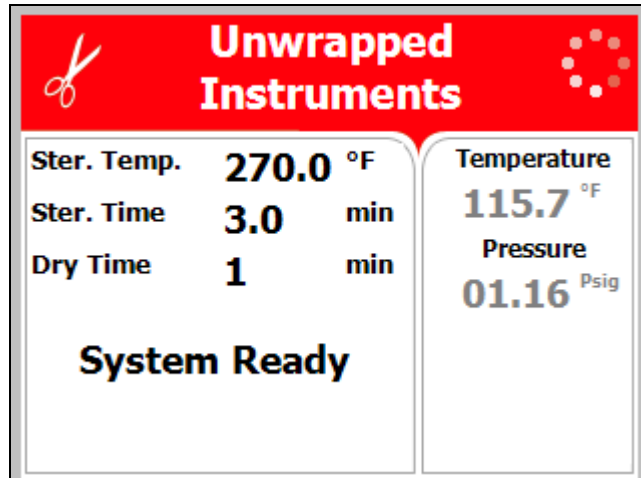

For unwrapped instruments and materials, when the instrument manufacturer recommends autoclaving at temperatures of 270°F (132°C) and no drying stage is required.

#### **Nominal parameters default settings**

- Sterilization temperature: 270°F (132°C)
- Sterilization time: 3 minutes.
- Drying time: 1 minute (may be increased by the operator (see sec. 7.1.1), other parameters are set and cannot be altered).

#### **Operations Sequence**

- Automatic water fill into the chamber and heating by actuation of electrical heaters until completion of the steam flush process.
- Positive air-removal pulses in the EZ11Plus to complete removing air from the chamber (not applicable to the EZ9Plus in this program).
- Heating by actuation of electrical heaters until the sterilization temperature is reached.
- Sterilization temperature is maintained constant for the preset sterilization time.
- Fast exhaust, steam is exhausted out of the chamber at a fast rate until pressure decreases to ambient pressure.
- Drying for 1 minute to remove residual steam from the chamber.



#### **CAUTION!**

**The sterility of instruments processed in unwrapped cycles cannot be maintained if exposed to non-sterile environment.**

## 6.2. Program 2: Wrapped Instruments, Pouches

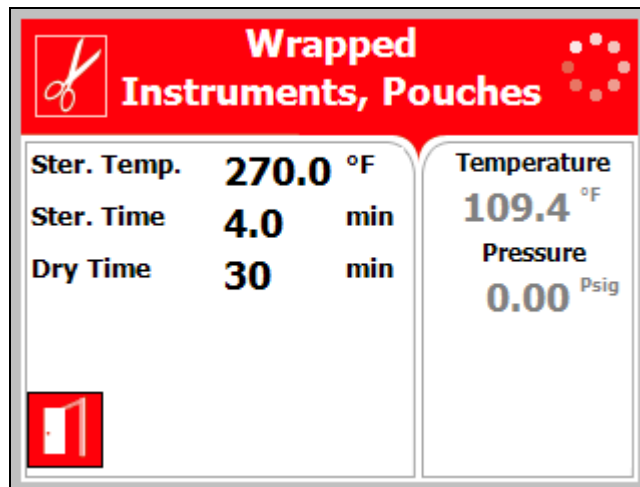

For wrapped instruments, pouches and materials, when the instrument manufacturer recommends autoclaving at temperatures of 270°F (132°C) with a drying stage.

### ***Nominal parameters default settings***

- Sterilization temperature: 270°F (132°C)
- Sterilization time: 4 minutes
- Drying time: 30 minutes (may be increased by the operator (see sec. 7.1.1), other parameters are set and cannot be altered).

### ***Operations sequence:***

- Automatic water fill into the chamber and heating by actuation of electrical heaters until completion of the steam flush process.
- Positive air-removal pulses to complete removing air from the chamber.
- Heating by actuation of electrical heaters until the sterilization temperature is reached.
- Sterilization temperature is maintained constant for the preset sterilization time.
- Fast exhaust, steam is exhausted out of the chamber at a fast rate until pressure decreases to ambient pressure.
- Drying by heating of chamber and air circulation to remove leftover moisture from the instruments and wraps.

### 6.3. Program 3: Unwrapped Delicate Instruments

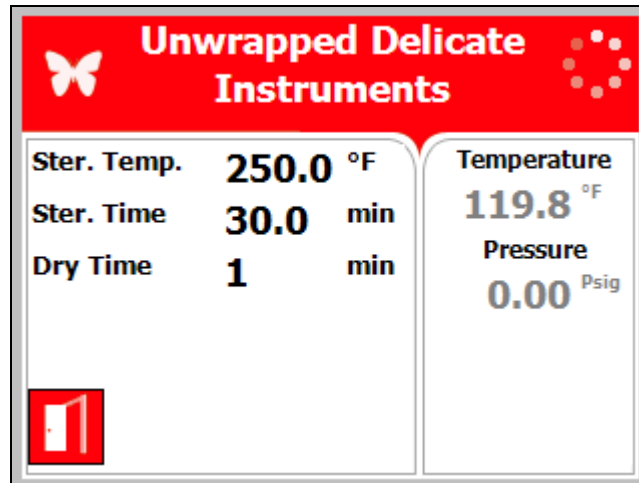

For unwrapped delicate instruments, when the instrument manufacturer recommends autoclaving at temperatures of 250°F (121°C) and no drying stage is required.

#### ***Nominal parameters default settings***

- Sterilization temperature: 250°F (121°C)
- Sterilization time: 30 minutes.
- Drying Time: 1 minute (may be increased by the operator (see sec. 7.1.1), other parameters are set and cannot be altered).

#### ***Operations sequence:***

- Automatic water fill into the chamber and heating by actuation of electrical heaters until completion of the steam flush process.
- Positive air-removal pulses in the EZ11Plus to complete removing air from the chamber (not applicable to the EZ9Plus in this program).
- Heating by actuation of electrical heaters until the sterilization temperature is reached.
- Sterilization temperature is maintained constant for the preset sterilization time.
- Fast exhaust, steam is exhausted out of the chamber at a fast rate until pressure decreases to ambient pressure.
- Drying for 1 minute to remove residual steam from the chamber.



#### **CAUTION!**

**The sterility of instruments processed in unwrapped cycles cannot be maintained if exposed to non-sterile environment.**

#### 6.4. Program 4: Handpieces

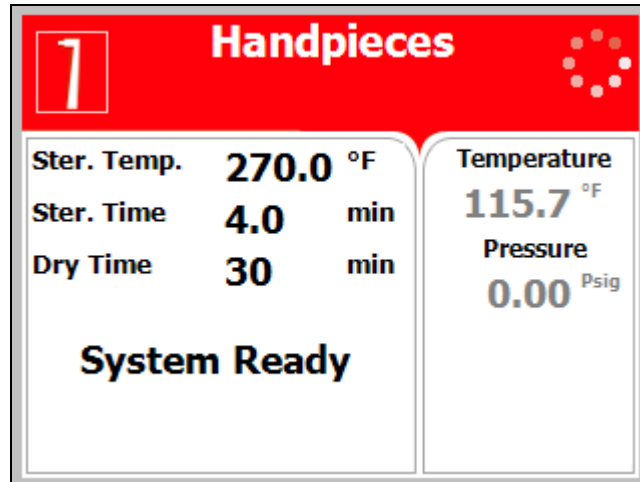

For wrapped Handpieces when the instrument manufacturer recommends autoclaving at temperatures of 270°F (132°C) with a drying stage.

**Note:** Tuttnauer recommends all Handpieces be wrapped for sterilization.

##### ***Nominal parameters default settings***

- Sterilization temperature: 270°F (132°C).
- Sterilization time: 4 minutes.
- Drying time: 30 minutes (may be increased by the operator (see sec. 7.1.1), other parameters are set and cannot be altered).

##### ***Operations Sequence***

- Automatic water fill into the chamber and heating by actuation of electrical heaters until completion of the steam flush process.
- Positive air-removal pulses to complete removing air from the chamber.
- Heating by actuation of electrical heaters until the sterilization temperature is reached.
- Sterilization temperature is maintained constant for the preset sterilization time.
- Fast exhaust, steam is exhausted out of the chamber at a fast rate until pressure decreases to ambient pressure.
- Drying by heating of chamber and air circulation to remove leftover moisture from the instruments and wraps.

## 6.5. Program 5: Chamber Brite Cleaning

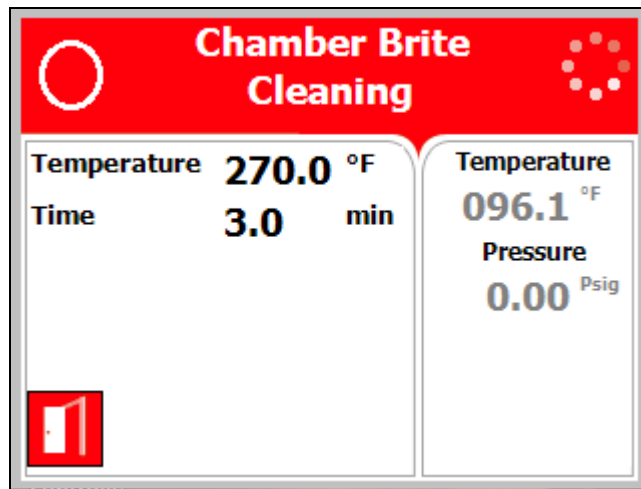

This is a maintenance cycle used with Tuttnauer's Chamber Brite™ cleaner for cleaning the chamber and piping of the autoclave. We recommend using Chamber Brite™ and cleaning the autoclave every 20 cycle or once per week whichever is longer. (see sec. 12.1.2 for detailed instruction on cleaning the chamber).



**CAUTION! This is not a sterilization program! This program has not been cleared by the FDA for sterilization.**

### ***Nominal parameters default settings***

- Cleaning temperature: 270°F (132°C).
- Cleaning time: 3 minutes.

### ***Operations sequence:***

- Automatic water fill into the chamber and heating by actuation of electrical heaters until completion of the steam flush process.
- Heating by actuation of electrical heaters until the cleaning temperature is reached.
- Cleaning temperature is maintained constant for the preset cleaning time.
- Fast exhaust, steam is exhausted out of the chamber at a fast rate until pressure decreases to ambient pressure.
- No Drying

The turquoise color of the screen, when the cycle is running, is intended to remind the user that the program is not a sterilization program.



## 6.6. Program 6: Calibration Cycle

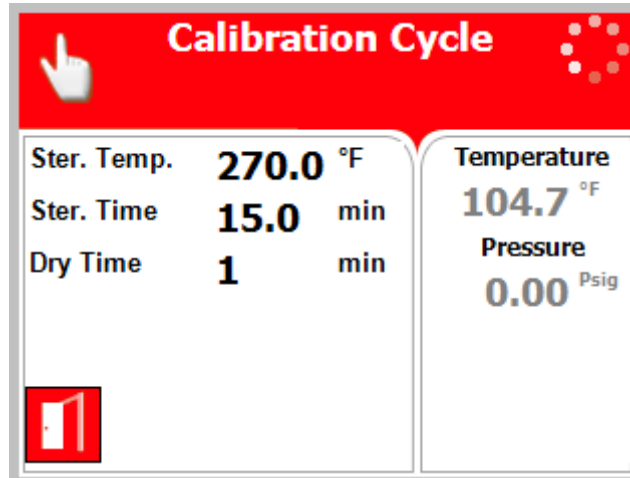

This program is only for use by a technician with the proper test equipment to aid in calibrating the autoclave. This is a shortened cycle with a long sterilization phase at 270°F (132°C) and no drying to facilitate the calibration process.



**CAUTION! This is not a sterilization program! This program has not been cleared by the FDA for sterilization.**

### ***Nominal parameters default settings***

- Calibration temperature: 270°F (132°C)
- Calibration time: 15 minutes.
- Drying time: 1 minute is the minimum value set when no drying is required.

### ***Operations Sequence***

- Automatic water fill into the chamber and heating by actuation of electrical heaters until completion of the steam flush process.
- Positive air-removal pulses to complete removing air from the chamber
- Heating by actuation of electrical heaters until the calibration temperature is reached.
- Calibration temperature is maintained constant for the preset calibration time.
- Fast exhaust, steam is exhausted out of the chamber at a fast rate until pressure decreases to ambient pressure.
- Drying for 1 minute to remove residual steam from the chamber.

### 6.7. Program 7: Custom A (may be altered by the user)

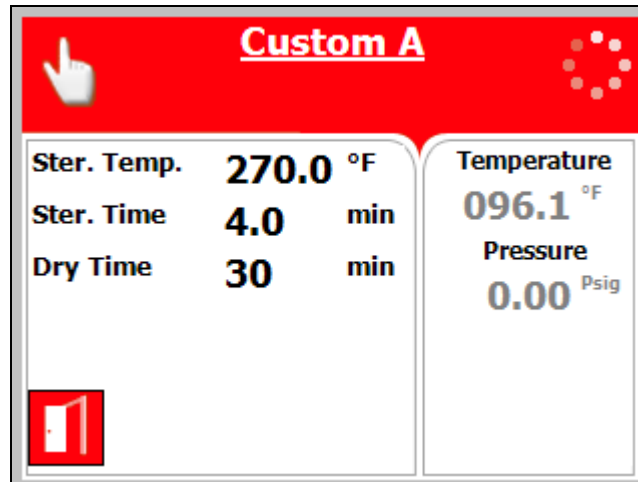

This program allows the user to adjust all cycle parameters in order to sterilize items that cannot be sterilized in any of the preceding default programs.



**This is not an FDA cleared program and validation of sterility when using this program is the responsibility of the user.**

See section 7 for instructions on how to create a custom program.

#### ***Nominal parameters default settings***

- Sterilization temperature: 270°F (132°C).
- Sterilization time: 4 minutes.
- Drying time: 30 minutes

#### ***Operations sequence:***

- Automatic water fill into the chamber and heating by actuation of electrical heaters until completion of the steam flush process.
- Positive air-removal pulses to complete removing air from the chamber.
- Heating by actuation of electrical heaters until the sterilization temperature is reached.
- Sterilization temperature is maintained constant for the preset sterilization time.
- Fast exhaust, steam is exhausted out of the chamber at a fast rate until pressure decreases to ambient pressure.
- Drying by heating of chamber and air circulation to remove leftover moisture from the instruments and wraps.

**6.8. Program 8: Custom B (may be altered by the user)**

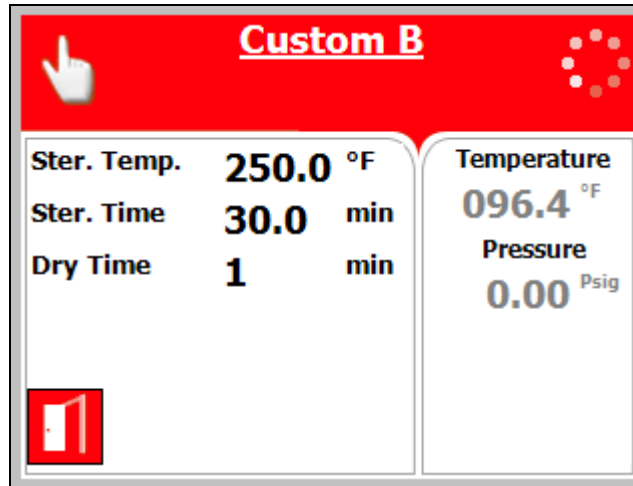

This program allows the user to adjust all cycle parameters in order to sterilize items that cannot be sterilized in any of the preceding default programs.



**This is not an FDA cleared program and validation of sterility when using this program is the responsibility of the user.**

See section 7 for instructions on how to create a custom program.

***Nominal parameters default settings***

- Sterilization temperature: 250°F (121°C).
- Sterilization time: 30 minutes.
- Drying time: 1 minute.

***Operations sequence:***

- Automatic water fill into the chamber and heating by actuation of electrical heaters until completion of the steam flush process.
- Positive air-removal pulses to complete removing air from the chamber.
- Heating by actuation of electrical heaters until the sterilization temperature is reached.
- Sterilization temperature is maintained constant for the preset sterilization time.
- Fast exhaust, steam is exhausted out of the chamber at a fast rate until pressure decreases to ambient pressure.
- Drying for 1 minute to remove residual steam from the chamber.

## 7. CHECKING AND CHANGING PARAMETERS AND OTHER DATA

This section shows how to access system data and modify parameters.

The Cycle Parameters directory containing parameters for controlling the sterilization process is locked for programs 1 thru 4 and not available for modification from the default values (except for drying).

Program 5 is a cleaning program and all parameters are locked.

Program 6 is a calibration program for use by a technician and all parameters are locked.

Two programs are available for the user to modify as needed, Custom A and Custom B. These custom programs are not FDA cleared and it is the user's responsibility to validate these programs.

### Spore testing is your only assurance of complete sterilization.

Once entering the programming mode, the operator will see and have access to the following directory items.

Directory		Subdirectory
Quick Options see sec. 7.1		Add extra dry time Export to USB Print cycles Version information Start cycle by clock Set date and time Login Exit
Main Menu (requires login) see sec. 7.2	Cycle Parameters – applicable only for Custom programs (except Dry Time) See sec. 7.2.1	Cycle Parameters
	System Parameters See sec. 7.2.3	Print Rate All
		Print Rate Sterilization
		Screen Saver
		Cycle Print Gap
	Maintenance See sec. 7.2.4	Export gain and offset to USB
		Reset atmospheric pressure
Printer test		
	Print all gain and offset	

### 7.1. Quick Options Directory

To take advantage of the system features it is necessary to access the programming mode. Some subdirectories enable the operator to see and change an individual cycle's parameters. Therefore it is necessary to choose the required cycle before entering the programming mode.

1. Enter the **programming mode** by pressing the **UP** and **DOWN** keys **simultaneously** for 1-2 seconds. When released the "Quick Options" screen will be displayed. Scroll up or down the list and press the **START/STOP** key to select. Some features will require an access code. The operator's access code is 0001.

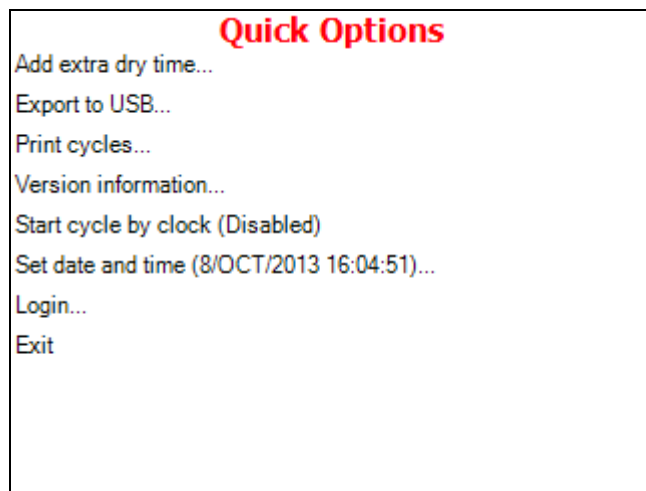

To exit this screen or any screen in this section, press the **UP** or **DOWN** key to move the cursor to **Exit** and press **START/STOP** key.

### 7.1.1. **Add extra dry time**

Accessing this parameter allows the operator to ADD additional drying time to the default drying time of the cycle selected.

As an example: If the program default is 30 minutes drying selecting 10 additional minutes will give a total drying time of 40 minutes. The additional drying time will remain as part of the cycle until changed back. To return to the original 30 minutes, select 0 additional minutes, now the total drying time will be 30 minutes.

1. Scroll up or down the list and press the **START/STOP** key to select.



### 7.1.2. *Export to USB*

**Note:** The USB flash drive needs to use FAT formatting.

Scroll up or down the list and press the **START/STOP** key to select.

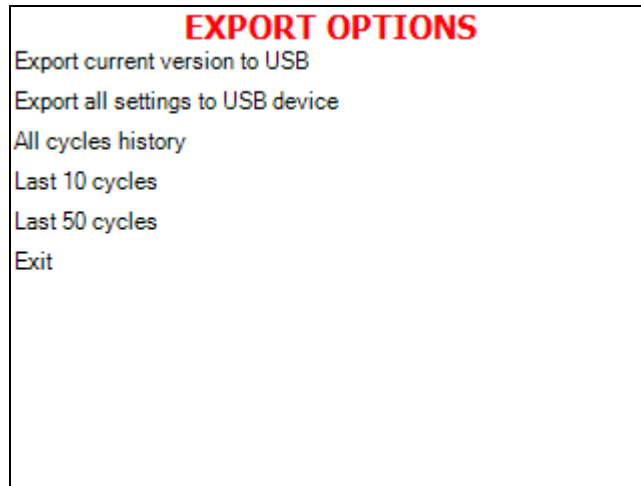

#### 1. Export current version to USB

Accessing the Export current version feature allows the operator to export the machine's current application for evaluation by a technician.

- a. Insert the USB device into the USB Socket located behind the printer door (See Sec. 4)
- b. Move the cursor to Export current version to USB device.
- c. Press the **START/STOP** key

The following screen will be displayed:

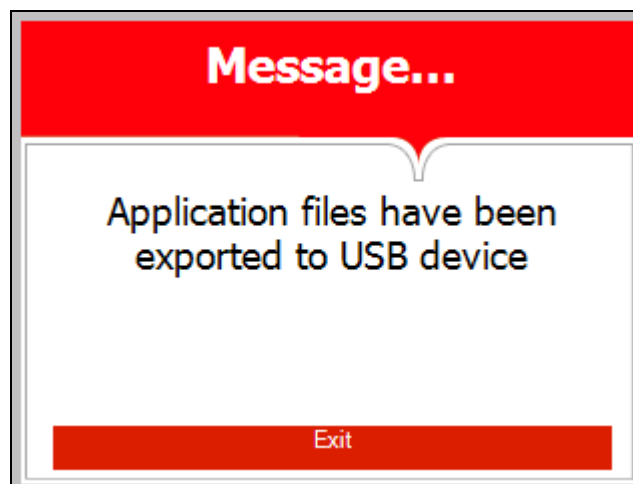

## 2.Export all settings to USB

Accessing the Export all settings feature allows the operator to export all the machines cycle settings for evaluation by a technician using Tuttnauer's R.P.C.R software.

- a.Insert the USB device into the USB Socket located behind the printer door (See Sec. 4)
- b.Move the cursor to Export all settings to USB device.
- c.Press the **START/STOP** key

The following screen will be displayed:

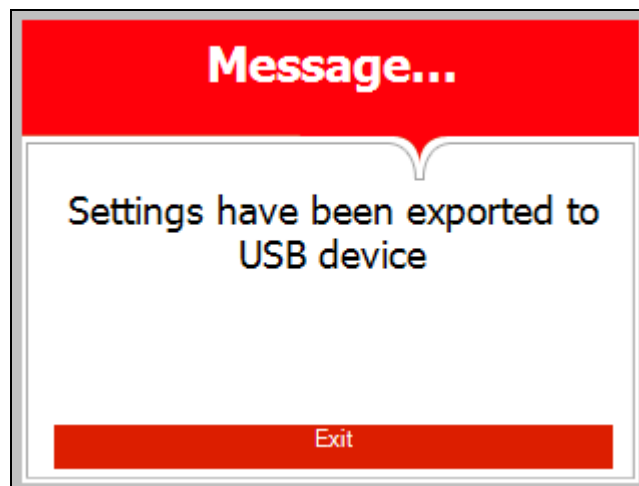



3.All cycle history

4.Last 10 cycles

5.Last 50 cycles

Accessing the export cycle history feature allows the operator to export cycle history of the previous 100 cycles to a USB device for evaluation or digital storage. Cycle data is exported in individual text file format (.txt) for viewing on a PC or with Tuttnauer's R.PC.R software. Exporting the cycle history will not automatically delete the cycle history.

- a.Insert the USB device into the USB socket located behind the printer door (see sec. 4)
- b.Move the cursor to select the number of cycles to export
- c.Press the **START/STOP** key.

The following screen will be displayed.

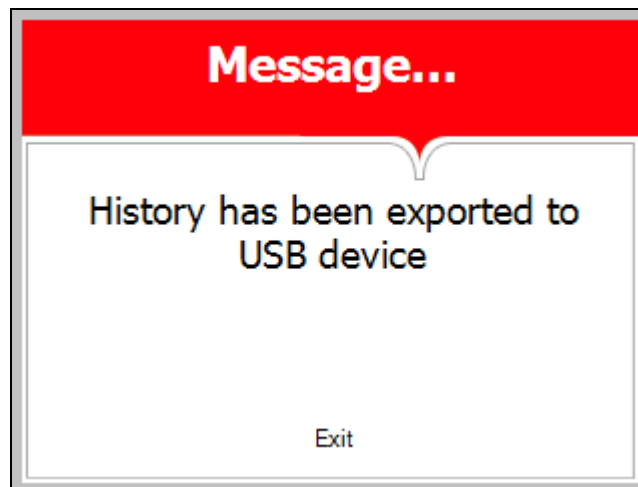

### 7.1.3. *Print cycles*

Select this option and the following screen will be displayed.

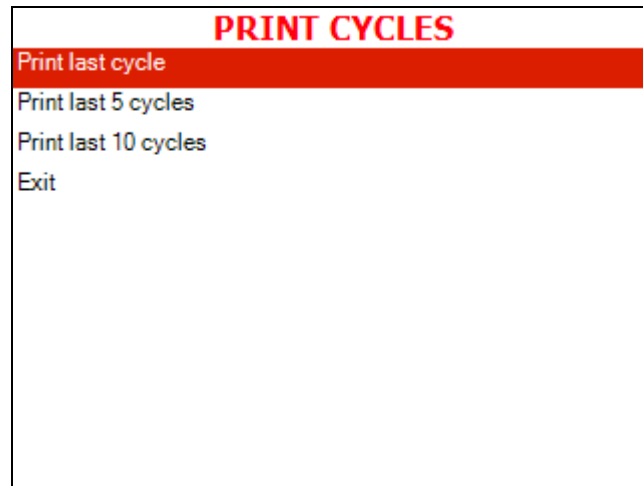

This subdirectory offers the following options:

- Print last cycle
- Print last 5 cycles
- Print last 10 cycles

The Print cycles feature requires that the machine have a printer installed. This feature allows the operator to print out the last cycle, the last 5 cycles or the last 10 cycles. Scroll down to the desired option and press the **START/STOP** key. Once the printer has finished scroll to Exit and pressing the **START/STOP** key will return to the main screen

#### 7.1.4. *Version information*

This subdirectory allows viewing of the current version of software running the machine.

Select this option and the following screen will be displayed.

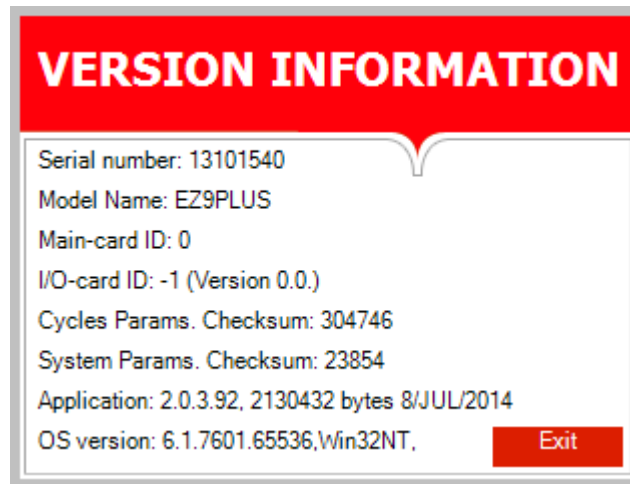

#### 7.1.5. *Start cycle by clock*

This option allows for scheduling the selected cycle to start at a later time (The maximum possible delay is 24 hours). No other program can be run while the Start Cycle by Clock is active.

Select this option and the following screen will be displayed:

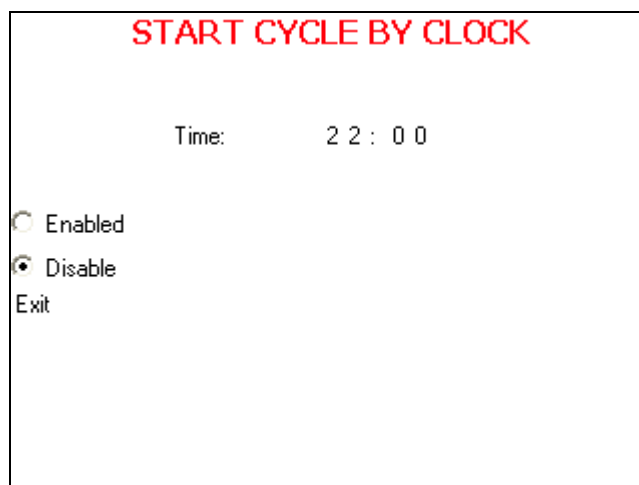

The time is displayed in the form “HH:MM”. The time is in a 24 hour format (i.e. 14:30 = 2:30 PM).

### **Enabling the Start Cycle By Clock**

1. Select the cycle to be scheduled from the Main Screen before enabling this option.
2. Set the start time by using the **UP** and **DOWN** keys to change the blinking digit. Use the **START/STOP** key to move to the next digit.
3. Use the **START/STOP** key to move the cursor to Enable.
4. Use the **UP** or **DOWN** key to select Enable.
5. Use the **START/STOP** key to move the cursor to exit.
6. Use the **UP** or **DOWN** key to exit.
7. The cycle is now enabled.

**Note:** When Start Cycle by clock is enabled this icon



will be displayed on the main screen.



### **Cancelling the Start Cycle By Clock**

Select the Start Cycle by Clock option from the Quick Options menu.

1. Use the **START/STOP** key to move the cursor to Disable
2. Use the **UP** or **DOWN** key to select Disable
3. Use the **START/STOP** key to move the cursor to exit
4. Use the **UP** or **DOWN** key to exit.
5. The cycle is now disabled.

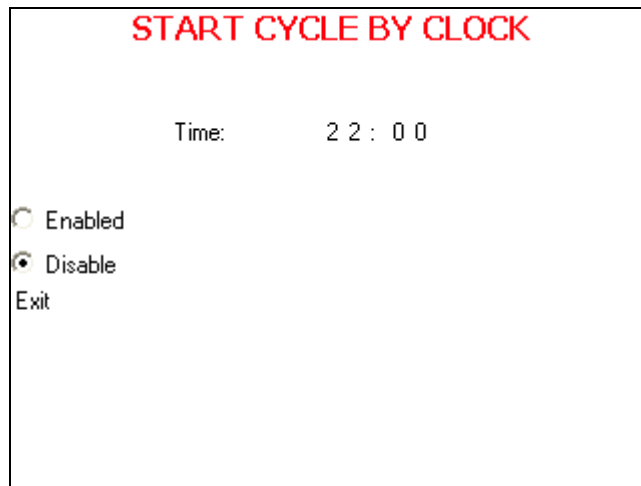

### 7.1.6. Set date and time

**Note:** It is important to set the date and time when setting up a new machine for the first time. The internal battery is turned off for shipping. Setting the date and time will restart that battery.

**Note:** Failure to set the Date and Time will cause a Time Error and the unit will not run properly.

This option enables the operator to set the date and time. The following screen will be displayed:

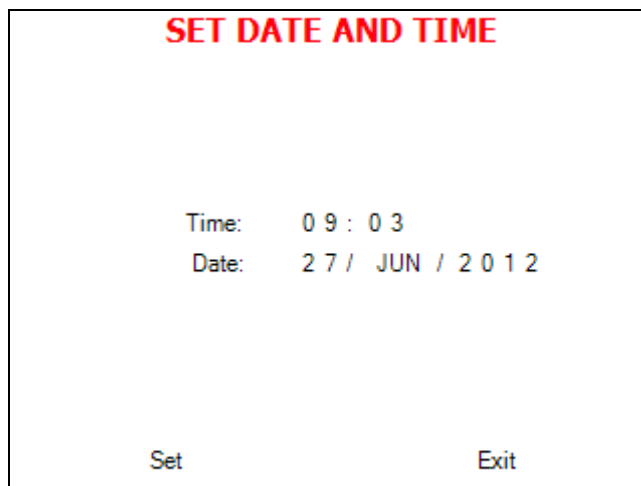

- The time is displayed in the upper row in the form “HH:MM”. The time is in a 24 hour format (i.e. 14:30 = 2:30 PM)
- To set the time use the **UP** and **DOWN** keys to change the blinking digit. Use the **START/ STOP** key to move to the next digit.

- The date is displayed in the lower row in the form “DD/MMM/YYYY” (e.g. 05/APR/2012)
- To set the date use the **UP** and **DOWN** keys to change the blinking digit. Use the **START/ STOP** key to move to the next digit.
- When all changes are completed, use the **START/ STOP** key to move to **SET**, then use the **UP** or **DOWN** key to save the new date and time.
- When saving is completed, the Set Date and Time screen is still displayed.
- Move the cursor to Exit and press the **UP** or **DOWN** key.
- Selecting exit will return to the Main screen where the next option can be selected.

**Note:: After setting time and date, the autoclave will restart automatically.**

#### 7.1.7. Login

Accessing additional feature requires entering a password, follow these steps

1. Select Login and press the **START/STOP** key.
2. The SELECT USER screen is displayed

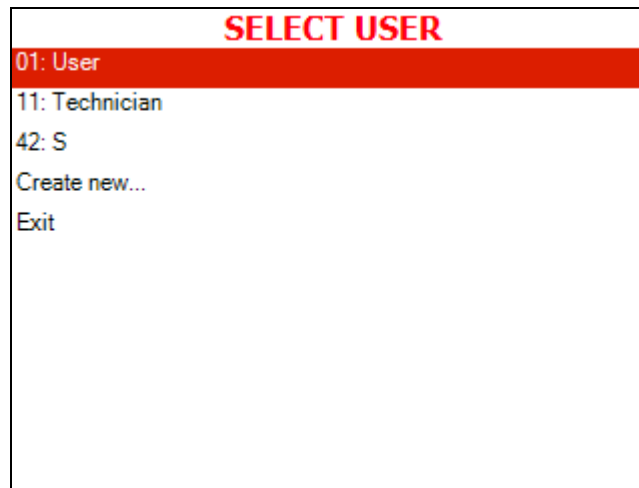

3. Move the cursor to User, if it is not already highlighted, and press START/STOP key
4. Enter Code screen is now displayed
5. 0000 is displayed on the screen with the cursor blinking on the right digit.

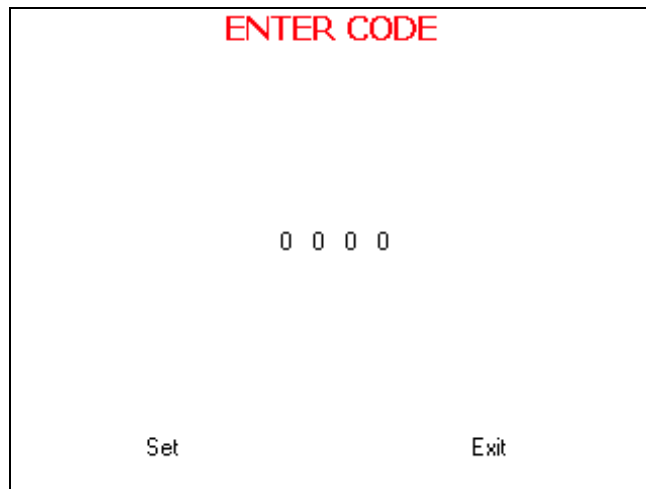

6. To increase or decrease the right digit, press the UP or DOWN keys.
7. Change the code to 0001 and move the cursor to SET by pressing the START/STOP key four times.
8. When SET is blinking, press the UP or DOWN key to enter the MAIN MENU screen.

The following screen is displayed:

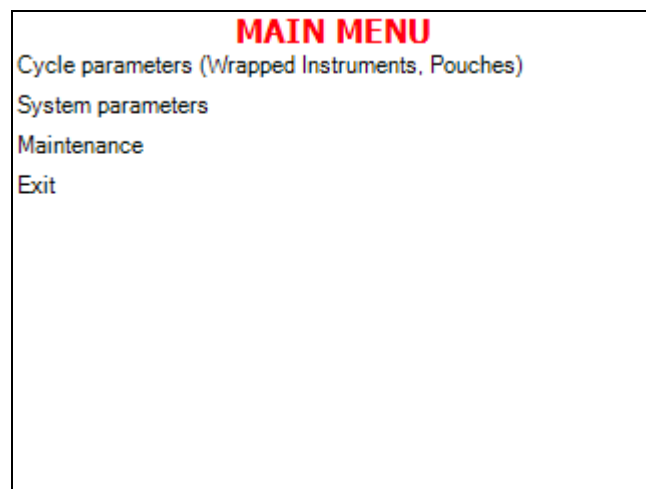

See section 7.2 for more details on the MAIN MENU.

#### **7.1.8. Exit**

Selecting Exit and pressing the **START/STOP** key, will bring you back to the main screen.

## 7.2. Main Menu

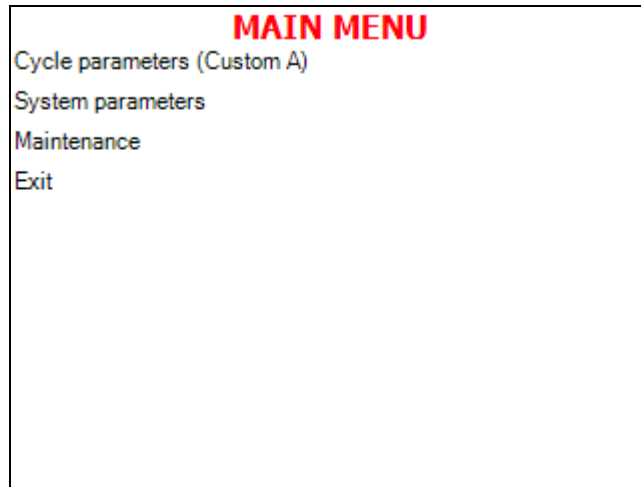

1. To browse through the subdirectories, use the **UP** and **DOWN** keys.
2. When the desired directory is blinking, press the **START/STOP** key. The required screen (see the following paragraphs) will be displayed.
3. To exit the **MAIN MENU** screen, press the **UP** or **DOWN** key to move the cursor to **EXIT** and then press **START/STOP**.
4. An explanation of the various directories, subdirectories and parameters can be found on the following pages.

### 7.2.1. Cycle Parameters for Custom A and B cycles

This directory enables the operator to see and change all the cycle parameters for Custom A and Custom B cycles. To modify a program it is necessary to select that program from the Main Screen before entering the "**MAIN MENU**" directory

This directory includes seven subdirectories. A description of each parameter can be found in see section 7.3

Subdirectory	Property
Create Pulse	Pulse A Count
	Pulse A Stay Time
	Pulse A Low Pressure
	Pulse A High Pressure
	Pulse B Count
	Pulse B Stay Time
	Pulse B Low Pressure
Pulse B High Pressure	



	Pulse C Count
	Pulse C Stay Time
	Pulse C Low Pressure
	Pulse C High Pressure
	Pulse D Count
	Pulse D Stay Time
	Pulse D Low Pressure
	Pulse D High Pressure
Heating	Sterilization Temperature
Sterilization	Sterilization Temperature
	Sterilization Time
Exhaust	Exhaust Mode
Drying	Dry Time
	Dry Heat On 1
	Dry Heat Off 1
	Dry first stage time
	Dry Heat On 2
	Dry Heat Off 2
	Additional Dry Time
Ending	End Temperature
Global	Multiple Cycles (Optional)
	Multiple Cycles Gap (Optional)
	Jacket Temperature

### 7.2.2. Modifying a parameter for the Custom A and B cycles

In the following example Pulse A Count will be modified

1. Using the **UP** or **DOWN** keys select the Custom A program from the Main Screen.

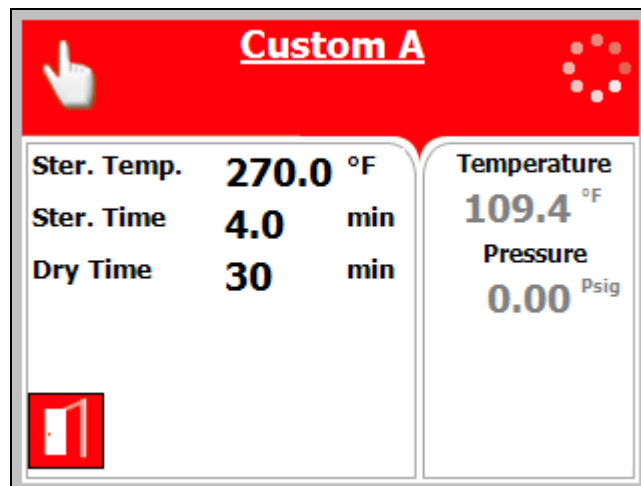

2. Enter the programming mode by pressing the **UP** and **DOWN** keys simultaneously for 1-2 seconds and then release.
3. Login using the User code 0001.

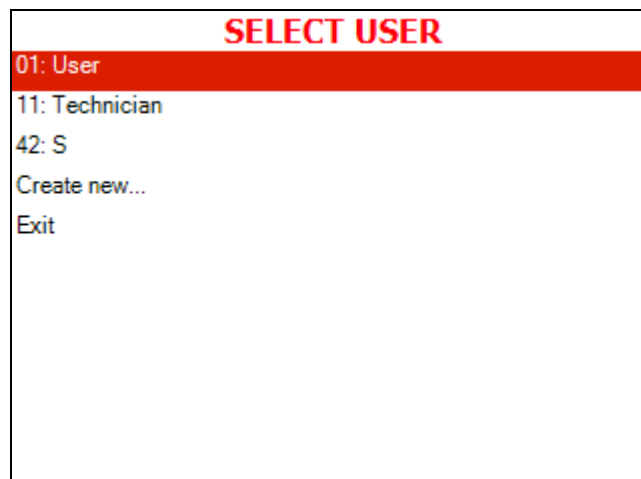

4. Select Cycle Parameters (Custom A) from the Main Menu.

<b>MAIN MENU</b>	
<b>Cycle parameters (Custom A)</b>	
System parameters	
Maintenance	
Exit	

- Use the **UP** or **DOWN** keys to move to the Create Pulse subdirectory as shown in the table in sec. 7.2.1. Pressing the **START/STOP** key will allow the user to enter that subdirectory.

<b>Custom A</b>	
<b>Create Pulse</b>	
Heating	
Sterilization	
Exhaust	
Drying	
Ending	
Global	
Exit	

- Pressing the **START/STOP** key again will select the individual parameter for modification.

<b>Custom A</b>	
<b>Pulse A Count</b>	<b>2.0</b>
Pulse A Stay Time	10.0 sec
Pulse A Low Pressure	18.85 Psia
Pulse A High Pressure	26.11 Psia
Pulse B Count	0.0
Pulse B Stay Time	2.0 sec
Pulse B Low Pressure	26.11 Psia
Pulse B High Pressure	29.01 Psia
Pulse C Count	0.0
Pulse C Stay Time	2.0 sec
Pulse C Low Pressure	23.20 Psia

- The Set Parameter screen will appear as shown with the current parameter setting highlighted. This screen is representative of a typical Set Parameter screen.

**SET PARAMETER**

Max: 99 min  
Min: 0 min  
Default: 1 min

Dry Time  
0 0 0 1 min

Set                  Exit

The Set Parameter screen shows the name of the parameter to be changed; it shows the maximum, minimum, and default values for this parameter. It also shows the current parameter setting.

- Use the **UP** and **DOWN** keys to change the desired value. See the table in sec. 7.3 to determine the appropriate value to use.
- Use the **START/STOP** key to advance the blinking cursor to **SET**. Use **UP** or **DOWN** key to enter the new value.
- Selecting **SET** or **EXIT** will return you to the previous screen where the next parameter can be selected for modification.
- Selecting **EXIT** before selecting **SET** will return to the previous screen without changing the parameter.

**The custom programs are not FDA cleared and it is the user's responsibility to validate any custom cycles**



**Spore testing is your only assurance of complete sterilization.**

### **7.2.3. System Parameters**

This directory allows for the modification of four parameters. These parameters apply to all programs.

- Print Rate all – defines the printing rate during all stages of the cycle except the sterilization stage. This feature requires a printer to be installed.
- Print Rate Sterilization – Defines the printing rate during the sterilization stage. This feature requires a printer to be installed.
- Screen Saver – defines the time interval from the last use of the Keypad until the screen saver is activated. Setting this parameter to 0 minutes will disable the screen saver.
- Cycle Print Gap – Defines the number of blank lines to advance at the end of the cycle. This feature requires a printer to be installed.
- 

### Modifying a system parameter

Every parameter can be changed as follows:

1. Select any program to modify the System Parameters
2. Enter the programming mode by pressing the **UP** and **DOWN** keys simultaneously for 1-2 seconds and then release.
3. Login using the User code 0001

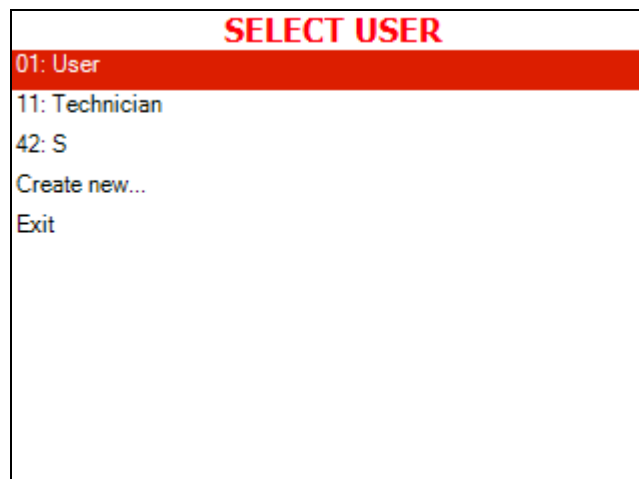

4. Select System Parameters from the Main Menu and press the **START/STOP** key. The following screen will appear.

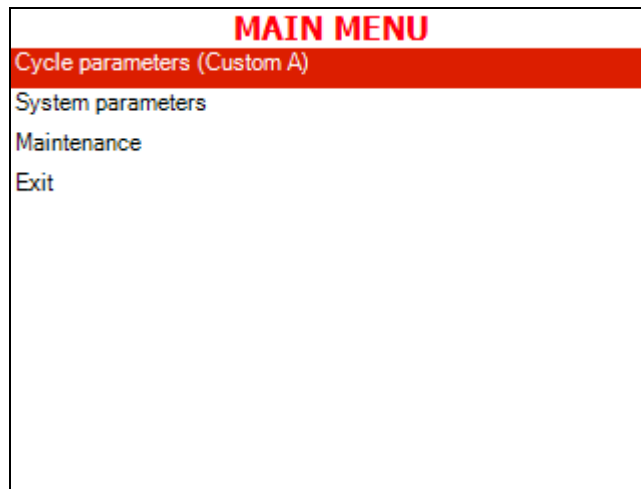

5. Use the **UP** or **DOWN** keys to move to the appropriate parameter from the system parameters screen.
6. Use the **START/STOP** key to select this parameter. The set parameter screen will appear.

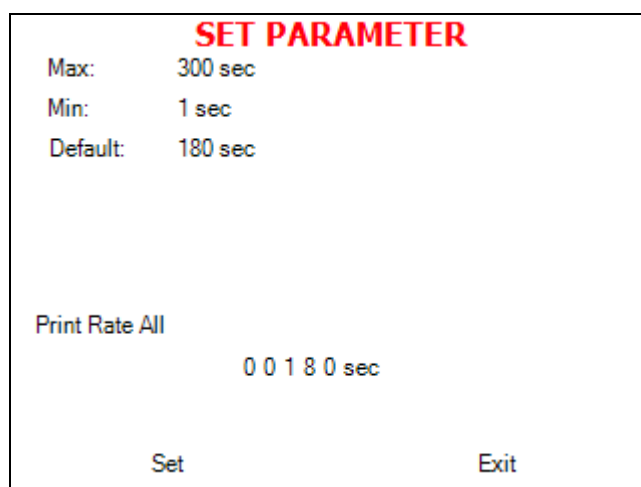
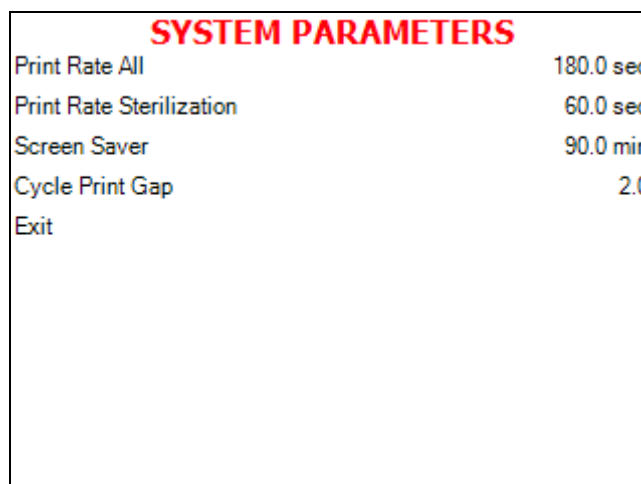

The Set parameter screen shows the name of the parameter to be changed; it shows the maximum, minimum, and default value for this parameter. It also shows the current parameter setting.

7. Use the **UP** and **DOWN** keys to change the desired value.
8. Use the **START/STOP** key to advance the blinking cursor to **SET**. Use **UP** or **DOWN** key to enter the new value.
9. Selecting **SET** or **EXIT** will return you to the previous screen where the next parameter can be selected for modification.
10. Selecting **EXIT** before selecting **SET** will return to the previous screen without changing the parameter.

#### **7.2.4. Maintenance**

This directory offers the following options. These options apply to all programs.

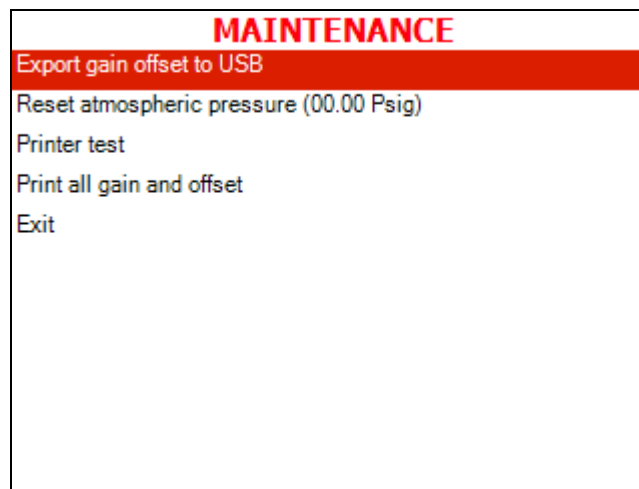

1. Select any program from the Main Screen to access the Maintenance options.
2. Enter the programming mode by pressing the **UP** and **DOWN** keys simultaneously for 1-2 seconds and then release.
3. Login using the User code 0001
4. Select Maintenance from the Main Menu and press the **START/STOP** key.

The following screen will appear:

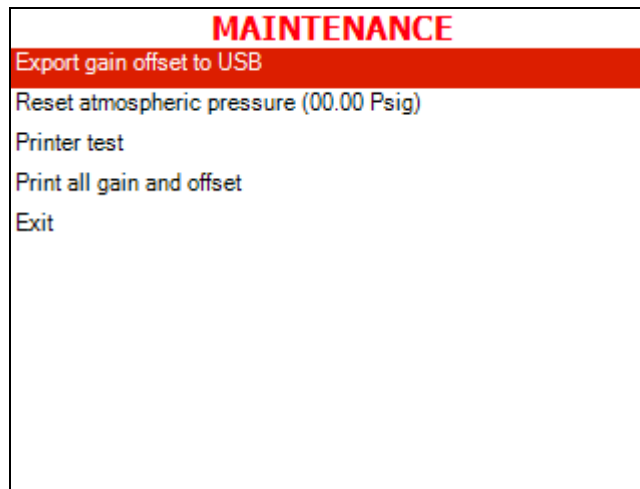

5. Use the **UP** or **DOWN** keys to move to the appropriate option from the maintenance screen.
6. Use the **START/STOP** key to select this option. The screen for that option will appear (see the screens for each option in the following sections).

#### **7.2.4.1.Export Gain and Offset to USB**

This option allows for exporting the gain and offset to a USB flash drive. This information is for use by a factory engineer.

**Note:** The USB flash drive needs to use FAT formatting.

1. Insert the USB device into the USB Socket located behind the printer door. (See sec. 4 ).
2. Move the cursor to Export gain offset to USB
3. Press the START/ STOP key.

The following screen will be displayed:



1. Remove the USB device from the USB socket.



To exit this screen and return to Maintenance screen press the **START/ STOP** key.

#### **7.2.4.2. Reset atmospheric pressure**

This is an option to manually reset the Atmospheric pressure parameter.

**Note:** The atmospheric pressure parameter is set automatically, however this parameter can be manually reset by using this option.

In order to reset the atmospheric pressure make sure the door is open and the chamber temperature is less than 113°F.

Move the cursor to Reset atmospheric pressure then press the **START/ STOP** key.

The following screen will be displayed:



In order to exit this screen, press the **START/ STOP** key.

### 7.2.4.3. Printer Test (for units with an optional printer)

This option enables the operator to test the printer

The printer will provide the following print out:

```
Leak
Internal error
Air detector
Purge time out
Bio filter time out
Emergency stop
VHP Timeout
Error close door
Error open door
High temp. (Ending)
Air error
High pressure (Ending)
High pressure (Dry)
High pressure (Exhaust)
High temp. (Cooling)
Low pressure (Cooling)
Time error
High temperature
Low temperature
High pressure
Low pressure
Heat time error (Ster.)
Heat time error (Keep)
Pressure time error
Vacuum time error
Heat time error
No water
Power down
I/O-card failed
Analog input error
Door is open
Canceled by user
Cycle errors:
248 = °
168 = ↓
Special Chars:
System vers.: 26254
Cycle vers.: 158645
I/O-card vers.: 7.3
Software vers.: 2.0.5.1
Time: 08:53:52
Date: 29/SEP/2014
POWER ON
Time: 18:54:39
Date: 28/SEP/2014
POWER OFF
-----
```

When the printer has finished, the following screen will be displayed:



In order to exit this screen, press the **START/STOP** key.

#### ***7.2.4.4. Print All Gain and Offset (for units with an optional printer)***

This option allows for printing all the gain and offset values. This information is for use by a factory engineer.

The printer will provide gain and offset for the following:

- Chamber temperature
- Chamber Pressure
- Chamber water level
- Mineral free Water Level

The following screen will be displayed:



In order to exit this screen press the **START/ STOP** key.

### 7.3. Table of Parameters

This option is only available for the Custom A and Custom B programs.

This table describes the function of each of the parameters that control the different parts of the sterilization cycle. Each parameter is available for modification by the user.

The default values shown in this table apply only to the Custom B program.

To modify a different program it is necessary to select that program before entering the "MAIN MENU" directory



**Custom A and Custom B programs are not FDA cleared. It is the user's responsibility to validate any Custom cycles.**

This device utilizes the Steam Flush Pressure Pulse technology for removing air from the chamber prior to sterilization. The Create Pulse parameters are what control this process. Inappropriate parameter modification can affect the quality of the sterilization process.



**Spore testing is your only assurance of complete sterilization.**

Parameters	Subdirectory	Description	Default	Units	Range	Resolution
Pulse A Count	Create Pulse	Defines the number of pulses in the first pulse group (group A)	2	Whole Number	0-10	1
Pulse A Stay Time		Defines the additional time that the top exhaust valve will remain open after reaching the pressure set by the Pulse A low Pressure parameter in the first pulse group.	10	Seconds	1-100	1
Pulse A Low Pressure		Defines the pressure that the top exhaust valve closes at the bottom of each pulse.	18.8 5	Psia	0.73 – 43.51psi a	.01
Pulse A High Pressure		Defines the pressure that the top exhaust valve opens at the top of each pulse.	26.1 0	Psia	0.73 – 43.51psi a	.01

Parameters	Subdirectory	Description	Default	Units	Range	Resolution
Pulse B Count		Defines the number of pulses in pulse group B.	0	Whole Number	0-10	1
Pulse B Stay Time		Defines the additional time that the top exhaust valve will remain open after reaching the pressure set by the Pulse B Low Pressure parameter in group B.	2	Seconds	1-100	1
Pulse B Low Pressure		Defines the pressure at which the top exhaust valve closes at the bottom of each pulse.	26.1 1	Psia	0.73 – 43.51psi a	.01
Pulse B High Pressure		Defines the pressure at which the top exhaust valve opens at the top of each pulse.	29.0 1	Psia	0.73 – 43.51psi a	.01
Pulse C Count		Create Pulse	Defines the number of pulses in pulse group C.	0	Whole Number	0-10
Pulse C Stay Time	Defines the additional time that the top exhaust valve will remain open after reaching the pressure set by the Pulse C low Pressure parameter in pulse group C.		10	Seconds	1-100	1
Pulse C Low Pressure	Defines the pressure that the top exhaust valve closes at the bottom of each pulse.		23.2 0	Psia	0.73 – 43.51psi a	.01
Pulse C High Pressure	Defines the pressure that the top exhaust valve opens at the top of each pulse.		26.1 1	Psia	0.73 – 43.51psi a	.01

Parameters	Subdirectory	Description	Default	Units	Range	Resolution
Pulse D Count		Defines the number of pulses in pulse group D.	0	Whole Number	0-10	1
Pulse D Stay Time		Defines the additional time that the top exhaust valve will remain open after reaching the pressure set by the Pulse D low Pressure parameter in pulse group D.	10	Seconds	1-100	1
Pulse D Low Pressure		Defines the pressure that the top exhaust valve closes at the bottom of each pulse.	23.2 0	Psia	0.73 – 43.51psi a	.01
Pulse D High Pressure		Defines the pressure that the top exhaust valve opens at the top of each pulse.	26.1 1	Psia	0.73 – 43.51psi a	.01
Sterilization Temperature	Heating	Defines the temperature that needs to be reached during heating in order to get to the sterilization stage.	250° F	°F	212 °F- 284 °F	0.5°
Sterilization Temperature	Sterilization	Defines the temperature that needs to be maintained during sterilization.	250° F	°F	212 °F- 284 °F	0.5°
Sterilization Time		Defines the length of time the sterilization temperature and pressure must be held.	30	Minutes	0-9999	0.5

Parameters	Subdirectory	Description	Default	Units	Range	Resolution
Exhaust Mode	Exhaust	This parameter allows four choices; Fast Exhaust Fast Exhaust if the chamber pressure is less than atmospheric + 4.5psi, otherwise Slow Exhaust Slow Exhaust Slow Exhaust if the chamber has not completed sterilization, otherwise Fast Exhaust.	1	Whole Number	1-4	1
Dry Time	Drying	Defines the total length of the drying cycle.	1	Minutes	0-99	1
Dry heat On 1		Defines the ON time portion of the duty cycle for the heating elements during the first stage of the drying cycle.	4	Seconds	0-120	1
Dry Heat Off 1		Defines the OFF time portion of the duty cycle for the heating elements during the first stage of the drying cycle.	12	Seconds	0-120	1
Dry First Stage Time		The total drying cycle can be divided into two stages. This parameter defines the length of the first stage. The second stage will start at the end of the first and last until the end of the total drying cycle.	10	Minutes	0-120	1

Parameters	Subdirectory	Description	Default	Units	Range	Resolution
Dry Heat On 2		Defines the ON time portion of the duty cycle for the heating elements during the second stage of the drying cycle.	4	Seconds	0-120	1
Dry Heat Off 2		Defines the OFF time portion of the duty cycle for the heating elements during the second stage of the drying cycle.	10	Seconds	0-120	1
Additional Dry Time		Defines the number of additional minutes to add to the default dry time	0	Minutes	0-60	1
End Temperature	Ending	Define the temperature at the end of the cycle that must be achieved before the cycle can end and the door be opened .	248 °F	°F	86°F-302°F	1
Multiple Cycles	Global	Defines the number of times the cycle should be repeated before the door is opened and the contents removed.	1	Whole Number	1-50	1
Multiple Cycles Gap		Defines the wait time between each repeated cycle.	2	Minutes	1-60	1



Parameters	Subdirectory	Description	Default	Units	Range	Resolution
Jacket Temperature		<p>This defines the chamber pre-heat temperature for the program selected. It is not recommended to go above 120°F. Too high a temperature will damage the autoclave. The pre-heat will maintain the chamber at this temperature between cycles and will begin immediately once the program is selected</p>	32° F	°F	32- 302°F	1

## **8. PRINTER**

### **8.1. Printer Output (for units with optional printer)**

The printing is on thermal paper with 24 characters per line and contains the following information:

- Date:
- Time:
- Ser. Num:
- Model:
- Software Version:
- Cycle Num:
- Cycle Name:
- Ster Temp:
- Ster Time:
- Dry Time:
- End Temperature:

When the sterilization cycle begins the printer starts printing the above data.

After the preliminary printing, the autoclave starts performing the sequence of operations of the cycle. The measured values of temperature and pressure are printed at fixed time intervals, according to the phase of the process, as shown in the table on the next page.

The data is printed from the bottom up, beginning with the date and ending with "Cycle Ended". For an aborted cycle, "Cycle Failed" and the Error message are printed (refer to "Displayed Error Messages/Symbols").

For an example of a typical printout, see the next pages.

Printer output			Description
Operator:	_____		To be filled in manually by operator
Time:	12:14:47		Time sterilization cycle ended
Cycle Ended <b>00:24:43</b>	213.3	0.0	Cycle finished time
D 00:24:43	213.3	0.0	The time, temperature and pressure during drying
D 00:23:43	224.0	0.9	The time, temperature and pressure during drying
E 00:23:43	224.0	0.9	The time, temperature and pressure during exhaust
E 00:22:08	273.5	30.5	The time, temperature and pressure during exhaust
CLK 2: CLK 1:	12:12:10:00 12:12:10:00		
S 00:22:07	273.5	30.5	The time, temperature and pressure during sterilization
S 00:22:06	273.5	30.5	The time, temperature and pressure during sterilization
S 00:21:06	273.6	30.4	The time, temperature and pressure during sterilization
S 00:20:06	273.5	30.4	The time, temperature and pressure during sterilization
S 00:19:06	273.8	30.5	The time, temperature and pressure during sterilization
S 00:18:06	273.5	30.4	The time, temperature and pressure during sterilization
CLK 2: CLK 1:	12:08:08:00 12:08:08:00		
H 00:18:04	273.4	31.0	The time, temperature and pressure during heating
H 00:16:35	262.9	23.3	The time, temperature and pressure during heating
H 00:13:35	240.3	20.1	The time, temperature and pressure during heating

A 00:00:45	127.7	0.0	The time, temperature and pressure during Air removal
A 00:00:04	114.5	0.0	The time, temperature and pressure during Air removal
F 00:00:23	111.0	00.25	The time, temperature and pressure during Steam Flush
W 00:00:00 3	231.3	00.0	The time, temperature and pressure during Water Insert
TIME	°F	Psig	
End Temp	248.0°F	End Temperature for the selected program	
Additional Dry Time	025min	Additional drying time for the selected program	
Dry Time:	001min	Drying time for selected program	
Ster. Time:	3.0min	Sterilization time for selected program	
Ster. Temp:	270.0°F	Sterilization temperature in chamber for selected program	
Cycle Num:	000001	Unwrapped Instruments	Cycle name
Software vers:	2.0.3.2		Cycle number
Model:	EZ9PLUS		Software version
Ser. Num:	000000000001		Model name
Time:	08:33:29		Model Serial number
Date:	9/FEB/2010		Time of turning on
POWER ON	The device is turned on		Date of turning on
Time:	00:00:00		Time of turning off
Date:	9/FEB/2010		Date of turning off
POWER OFF	The device is turned off		

### Legend

A	Air removal stage (Pulse L & Pulse H)	D	Drying stage
H	Heating stage	CLK 1	Real Time Clock
S	Sterilization stage	CLK 2	Software clock
E	Exhaust stage	F	Steam Flush
W	Water Filling		

## 8.2. **Printer Handling (for units with an optional printer)**

### 8.2.1. **Maintenance**

Wipe off any soiling on the printer surface with a dry soft cloth with a weak neutral detergent. After that, wipe the printer with a dry cloth.

### 8.2.2. **Installing printer paper**

**Printer model PLUS II** front view (see Fig. 1)

1-Paper mouth

2-Power On Led

3-Open Button (for opening the paper roll compartment)

4-Paper Feed key

5-Paper roll compartment

6-Paper end of roll sensor

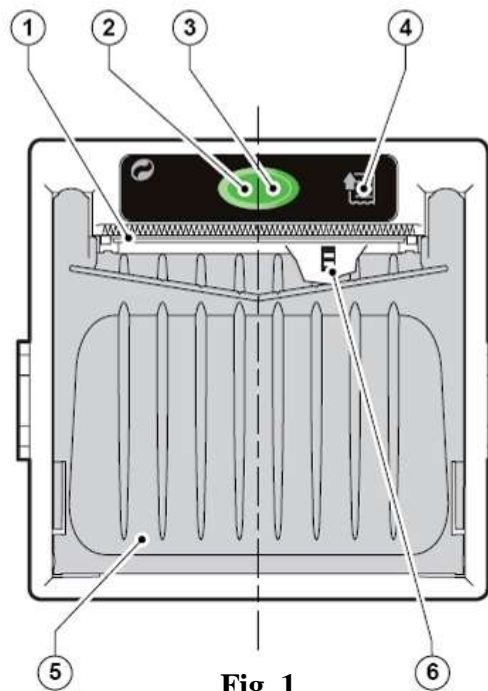

1. Open the printer's cover door (3) by pulling it at the left bottom corner (2) (see Fig. 2).

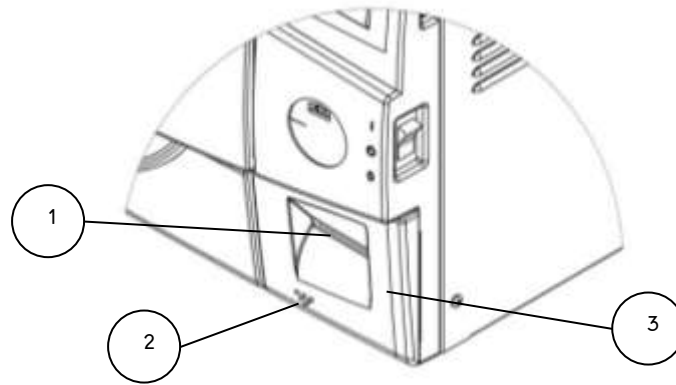

**Fig. 2**

2. Press the OPEN button to open the printer cover as shown (see Fig. 3/1). Handle the paper cutter carefully so as not to cut your hand.
3. Place the paper roll making sure it unrolls in the proper direction as shown (see Fig. 3/2).
4. The paper should roll off the top of the roll.
5. Hold the loose end of the paper with one hand and re-close the cover with the other hand as shown (see Fig. 3/3) the printer cover is locked.
6. Tear off the exceeding paper using the jagged edge (see Fig. 3/4).

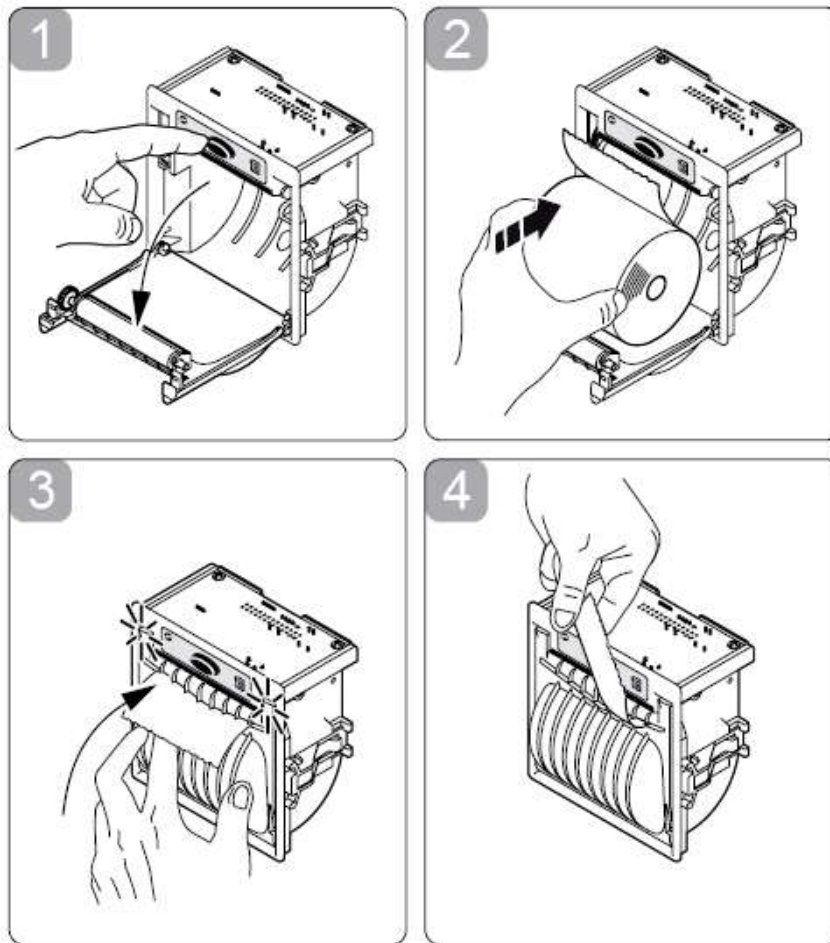

**Fig. 3**

7. Close the printer's cover door (3) by pressing corner (2), with the tip end of the paper emerging from the slot (1). See Fig. 2 on previous page.

**8.2.3. Notes on treatment of thermal papers:**

- Store the papers in a dry, cool and dark place.
- Do not rub the papers with hard substance.
- Keep the papers away from organic solvent.



**CAUTIONS!**

**Never disassemble the printer. Failure to follow this instruction may cause overheating or burning of the printer or AC adapter or an electric shock, which may lead to fire or personal injury.**

**Use caution when cleaning the printer or autoclave. Splashing water, cleaning solution or other liquids into the printer can cause fire or electrical shock.**

**Never touch the thermal head immediately after printing as it becomes very hot. Make sure that the thermal head is cool before setting papers or cleaning the thermal head.**

**Power OFF the autoclave in any of the following cases:**

- The printer does not recover from an error.
- Smoke, strange noise or smells erupt from the printer.
- A piece of metal or any liquid touches the internal parts or slot of the printer.



## 9. INSTALLATION INSTRUCTION

### 9.1. Lifting and carrying



**CAUTION!**

Any time the autoclave is to be moved, make sure that the electric cord is disconnected from the power source, and there is no pressure in the chamber.



1. Disconnect the power supply cord from the rear of the autoclave.
2. Drain any water that may be in the reservoir or chamber.

**Note:** Lifting straps have been provided with this unit.

To avoid injuries, lifting and carrying should be done by two people.

**Do not drop the device!**

### 9.2. Placing



**CAUTION!**

The sterilizer must be placed on a rigid and leveled surface. The counter top or stand must be able to withstand the load of the device and loaded material. See sec. 3.3 for unit specifications.

**Note:** This unit requires a minimum counter depth of 22"

**Note:** Make sure while placing the autoclave, to leave space around the machine for ventilation and to give the technician access to service the machine. It is recommended that a minimum 2" (50mm) space be provided. Insufficient space for ventilation may result in an increase of the autoclave's temperature which may damage the unit.

### 9.3. Electrical

The electrical connection should comply with the devices power requirement. It must also comply with local installation and safety rules and regulations. The voltage supplied to the device must comply with the device label  $\pm 5\%$ .

**Note:** It is recommended that the device be on a dedicated electrical circuit.

**Note:** The autoclave **must** be connected to a properly grounded outlet.

In order to avoid any personal injury due to electrical shock, it is mandatory to have installed an earth leakage relay (GFCI outlet or circuit breaker) in the electrical circuit to which the autoclave is connected. This relay disconnects all electrical power in case of accidental contact with any electrically energized parts of the autoclave,

#### **9.4. Setup**

Your new Tuttnauer Autoclave was programmed and tested at the factory and requires a minimum of setup.

1. Make sure the counter is level and sturdy see sec. 9.2 above.
2. Make sure all the feet are on the autoclave and none of them has been lost.
3. Position the autoclave on the counter see sec. 9.2 above
4. Connect the power cord to the socket on the rear side of the autoclave; then plug it into the supply outlet.
5. Turn on the power switch located on the right side of the unit. Set Date and Time will appear on the screen. On initial set up it is important to set the date and time see sec. 7.1.6.
6. This machine is equipped with an electronic door lock. The door will not open when the power is off or the display screen does not read **System Ready**.
7. When the software has finished loading the door will unlock. Open the door and immediately use the arrow keys on the EZPad to advance to the Unwrapped Cycle. This will turn off the pre heating mode (only the EZ11Plus is equipped with a pre-heat mode and only in the "Wrapped Instruments, Pouches". "Handpiece" and "Custom A" cycles). Make sure to remove all accessories and plastic material from the chamber.
8. Fill the reservoir (see sec. 9.5) with steam distilled water (see sec. 3.8)  
The unit is now ready to run sterilization cycles.

**Note:** At the time of installation or anytime the unit is relocated the atmospheric pressure parameter will automatically reset. The atmospheric pressure parameter can be manually reset at any time (See sec. 7.2.4.2 ).

#### **9.5. Filling the Mineral-Free Water Reservoir.**

**Only fill the reservoir when the autoclave is idle, not running a cycle.**

**Use only steam distilled water having the characteristics described in sec. 3.8**

1. Open the door (1). The autoclave needs to be on for the door to open.
2. Pour steam distilled water, gently, into the front funnel (2) until it reaches the top of the blue area (3) on the level gauge. If water is filled above the blue area into the red area (4) then use the drain hose to drain off the over fill (see sec. 12.2 ). It is preferable to use a carafe or small pitcher when filling.

**Note:**

This reservoir is designed with an over flow and filling the reservoir above the safe level as indicated on the Front Fill Funnel will cause excess water to spill out below the machine onto the counter.



**CAUTION!**

**Under no circumstance should water be filled higher than the blue area (3) on the level gauge.**

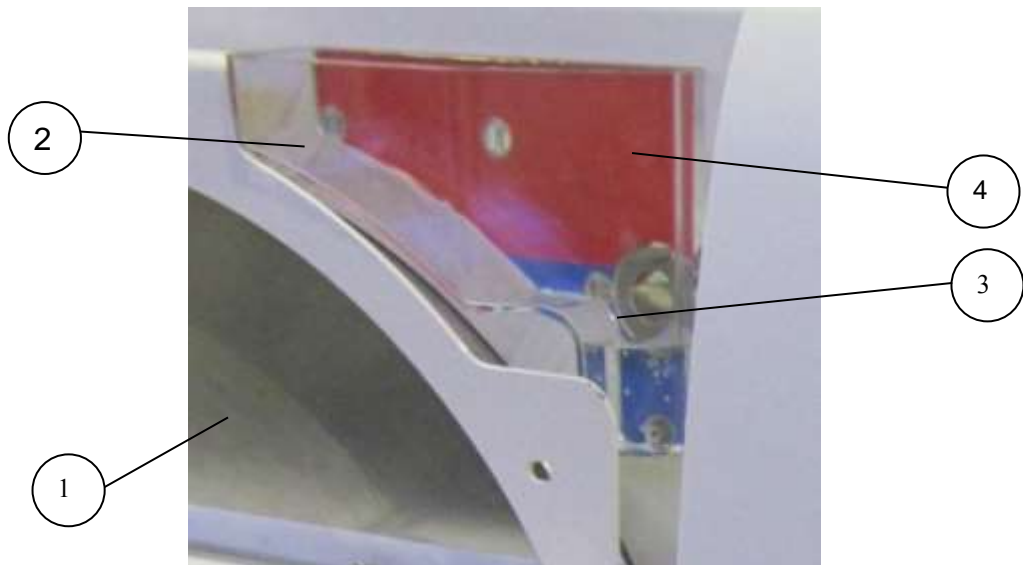

3. If the reservoir is empty, it can be filled quickly by adding water directly through the opening at the top of the reservoir, as follows:



**CAUTION!**

**Before filling the reservoir, verify that the autoclave is not running a cycle.**

**Note:**

This reservoir is designed with an over flow and filling the reservoir above the safe level as indicated on the Front Fill Funnel will cause excess water to spill out below the machine onto the counter.

4. Remove the water reservoir cover (6).
5. Pour steam distilled water into the reservoir through the opening on top of the autoclave until it reaches the base of the safety valve holder (7) or reaches the top of the blue area of the level gauge.



**CAUTION!**

**Under no circumstance should water be filled above the safety valve holder.**

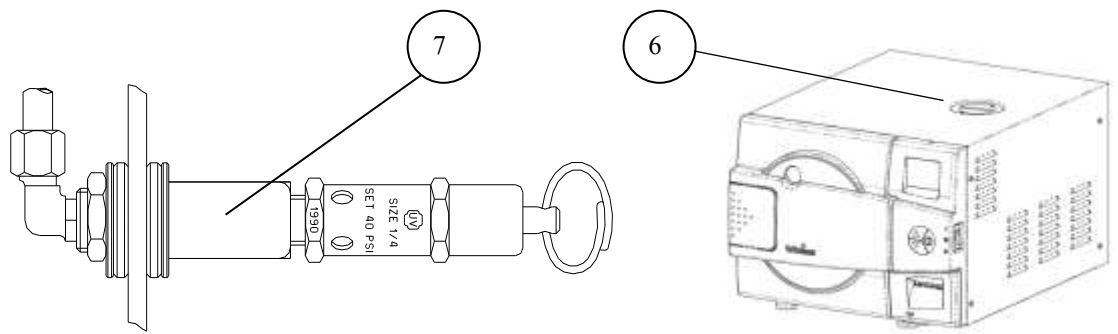

In case more water is accidentally filled above the blue area, or safety valve decrease the water level by draining the reservoir before starting a cycle (see sec. 12.2 ).



**CAUTION!**  
**USE STEAM DISTILLED WATER ONLY** having the characteristics as per table in sec. 3.8. The impurities in water from a well, spring or municipal water supply will create the need for more frequent cleaning and maintenance  
This type of water can damage your unit and void your warranty.

## 10. PREPARATION BEFORE STERILIZATION

The purpose of packaging and wrapping of items for sterilization is to provide an effective barrier against contamination once the items have been sterilized and removed from the sterilizer.

Packaging and wrapping materials should permit the removal of air from the pack during heating, penetration of the steam vapor into the pack during sterilization and removal of the steam vapor during drying.

The basic principle determining the size, mass and contents of instrument pouches, cassettes and hollowware packs is that the contents are sterile and dry immediately on completion of the drying cycle and removal from the sterilizer.

Instruments to be sterilized must be free from any residual matter, such as debris, blood or organic tissue. Instruments must also be dry and free from mineral deposits. Such substances may cause damage to the instruments themselves or the sterilizer.

Correct loading of the autoclave is essential for successful sterilization. Efficient air removal from the chamber and load will permit total steam penetration and saturation. Additionally, correct loading will promote efficient drying and reduce damage to packs and their contents and maximize the effectiveness of the sterilizer.

1. Check the instructions of the instrument manufacturer as to the proper procedure for cleaning and sterilizing each item. The instrument manufacturer's instructions always supersede any other instructions.
2. Clean instruments immediately after use to remove any residue. It is recommended that all instruments be ultrasonically cleaned using **Tuttnauer™ Clean & Simple** enzymatic cleaning tablets or other suitable solution.
3. After cleaning, rinse instruments under tap water for 30 seconds and pat dry to remove residual minerals. If your tap water has a high mineral content then rinse a second time in a bath of distilled water to remove minerals and pat dry.
4. Launder textile wraps prior to sterilization, thoroughly rinse wraps laundered in chlorine bleach. Chlorine bleach can harm your stainless steel instruments and the sterilizer.
5. Follow the instrument manufacturer's instructions on the use of products for cleaning and lubricating instruments that have been ultrasonically cleaned.
6. Be sure that instruments of dissimilar metal (stainless steel, carbon steel, etc.) are separated. Carbon steel instruments should be bagged or placed on autoclavable towels and not directly on stainless steel trays (mixing will result in damage to the instruments or trays from the electrolysis of these materials).
7. Load items within the boundaries of the tray so that they do not touch the chamber walls, or fall off when the tray is moved. Items

should not be allowed to touch the walls of the Chamber as the hot metal can damage the item.

8. Don't overload the sterilizer trays. Overloading will inhibit sterilization and produce poor drying results.
9. Items must be sterilized in an open position. Surfaces that are hidden because the item is in a closed position will not be exposed to the steam and will not be sterilized.

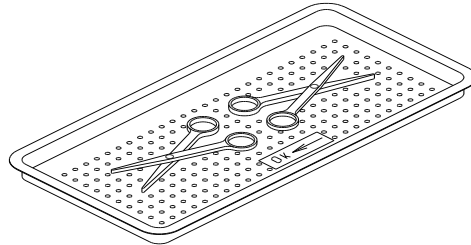

10. Make sure that all instruments remain apart during the sterilization cycle. Surfaces that are hidden because items are covering other items will not be exposed to steam and will not be sterilized.
11. Disassemble or sufficiently loosen multiple-part instruments prior to packaging to permit steam to come into contact with all parts of the instrument.
12. Verify that packaging methods are in accordance with the good practice approach and the packaging materials used are in agreement with applicable standards.
13. Tilt on edge items prone to entrap air and moisture, e.g. hollowware, so that only minimal resistance to removal of air, the passage of steam and condensate will be met.
14. Allow a distance of approximately 1" (2.5 cm) between trays to permit steam circulation.
15. Wrapped instruments should be placed in material which will allow steam penetration and promote drying, such as autoclave bag, autoclave paper, or muslin towels.
16. When using a paper / plastic bag, the plastic side should always be up.
17. Do not stack pouches. It is recommended that a pouch rack such as the **Tuttnauer™ Pouch Rack** be used to ensure proper steam penetration and adequate drying. Surfaces that are hidden because the items are being stacked will not be exposed to the steam and will not be sterilized.

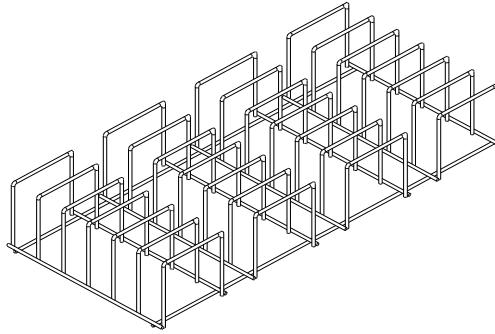

18. Empty canisters should be placed upside-down, in order to prevent accumulation of water (see the figure below).
19. When sterilizing glassware use only heat-proof glass. Glassware needs to be placed on the tray with the open end down.



20. Tubing should be rinsed after cleaning. When placed in the tray making sure that both ends of the tubing are open and there are no sharp bends or twists.

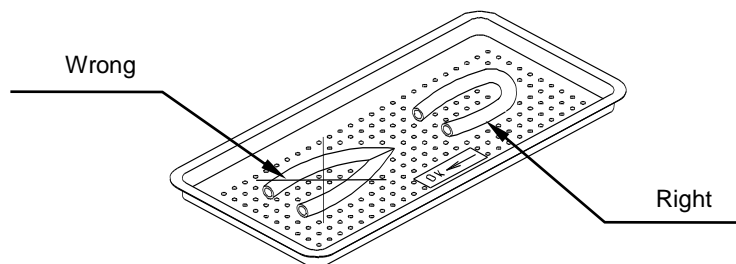

21. Cassettes or packs should be placed on the tray rack in place of the trays. They should not be touching each other or the Chamber walls. There should be about 1/2" between cassettes or packs for proper steam circulation. Cassettes in an EZ9Plus should be sterilized in a horizontal position (see the figure below).





22. Cassettes in an EZ11Plus should be sterilized in a vertical position (see the figure below).

To adjust the rack for vertical sterilization of cassettes remove the trays and gently squeeze the sides of the rack inward and at the same time rotate the rack into a vertical position.



23. Small packs can be placed directly on the tray in an upright position. They should not be touching each other or the Chamber walls. There should be about ½” to 1” between packs for proper steam circulation.

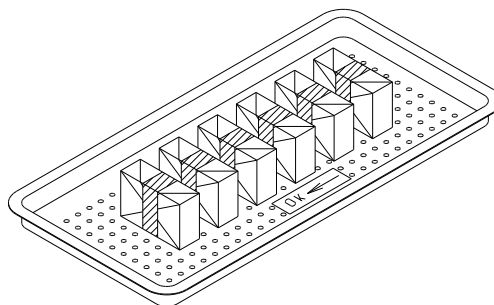

- 
24. Place a sterilization indicator on each tray and/or inside each wrapped cassette.
  25. At least once a week use a biological spore test (*Bacillus Stearothermophilus*) in any load to insure proper sterilization (be aware testing standards may vary). Always follow the spore test manufacturer's instruction.
  26. If spotting is detected on the instruments it is necessary to determine if the spot is dirt or oxidation. The first step would be to use an ordinary eraser to remove the spot. If there is no pitting under the spot then the spot is only dirt. Dirt spots on an instrument may be an indication that the autoclave needs to be cleaned or that the instruments were not adequately cleaned prior to sterilization. If removal of the spot reveals pitting then the spot is most likely oxidation. Oxidation spots on an instrument are not uncommon on inexpensive instruments. It may also be an indication that the instruments were rinsed in tap water with a high mineral content. These minerals when exposed to high temperature and steam will accelerate the oxidation of the metal. One suggestion would be to final rinse the instruments in a distilled water bath and pat dry to absorb residual water and minerals.
  27. If the instruments exhibit a discoloration this can be due to the mixing of carbon steel and stainless steel. When these two metals come into contact with each other electrolysis occurs that breaks down the metal. The best solution is to separately wrap the carbon steel instrument to insulate it from other instruments on the tray and from the tray itself.
  28. This unit is not approved for sterilizing liquids of any type.

## 11. OPERATING INSTRUCTIONS

### 11.1. Turning on the autoclave

1. Plug the power cord into the back of the autoclave and into the wall outlet.
2. Turn on the rocker switch mounted on the side of the front panel.

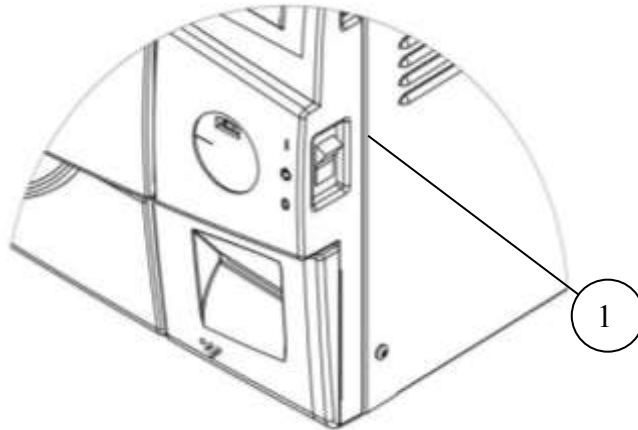

### 11.2. Pre-Heating (EZ11Plus only)

This feature keeps the chamber hot between cycles to provide optimal drying results when running the “Wrapped Instrument, Pouches” or “Handpiece” or “Custom A” cycles. Pre-heating is active during stand-by unless the autoclave is in screen saver mode. The screen saver mode is set to activate after 90 minutes of inactivity, to modify this time see sec. 7.2.3.

**Note:** Pre-heating activates automatically every time you turn the autoclave on and the “Wrapped Instrument, Pouches”, “Handpiece” or “Custom A” cycles are selected.. Use caution since pre-heating will make the bottom of the chamber hot.

If you press start during pre-heating, the following screen appears:

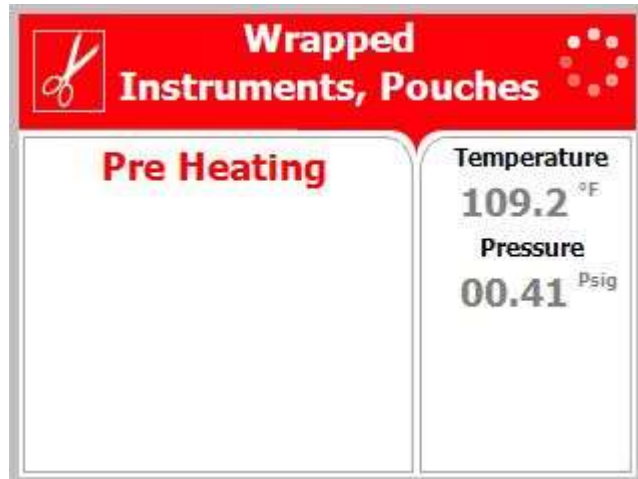

In this case, there is no need to press start again: when the required pre-heat temperature is reached, the process will start automatically.

Pressing start again will result in the following screen:



### 11.3. Opening the door

This machine is equipped with an electronic door lock. The door will not open when the sterilizer is running a cycle or the power is off or the display screen does not say “**System Ready**”.

When “**System Ready**” is displayed on the screen, open the door by following these steps:

1. Place your thumb on the plastic door cover (1) and the other fingers in the handle (3).
2. Pull the handle (2) until the latch of the door is released.
3. Open the door.

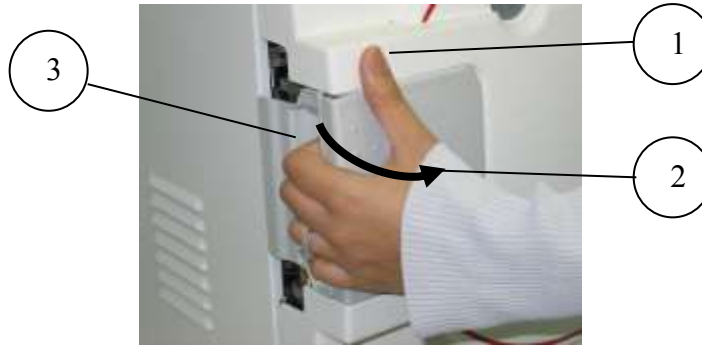

4. With the door open you can now fill the reservoir as per instructions in section 9.5

**Note:** The first time you start the unit it is important to set the date and time (see sec. 7.1.6)

#### **11.4. Adding additional drying time**

If the default drying time is not adequate for the load to be sterilized, additional drying time can be added. See sec. 7.1.1 for detailed instructions on adding extra drying time.

Tuttnauer strongly suggests that each user/operator learn how to arrange the load and apply additional drying time. This will ensure that your sterilizer provides efficient drying of the pouched and/or wrapped instruments used in your office

Tuttnauer affords you the ability to adjust drying times to accommodate various instrument loads. Since no two instrument loads are the same it is important to match the drying time with the load. In addition, proper packaging is important. Like materials should be packaged together. Carbon steel should not be mixed with stainless instruments. Plastic instruments should be separated from metal instruments. Pouched items should be separated on the tray and should only be one layer deep. When using paper/poly bags the paper side should be down. Using a Tuttnauer Pouch Rack will insure good air circulation and more efficient drying .

#### **11.5. Loading**

1. Load the autoclave properly according to instructions in sec. 10.
  - Be sure that instruments of dissimilar metal (stainless steel, carbon steel, etc.) are separated (see sec. 10 #6).
  - Observe maximum weight limits as referenced in the table in sec. 3.3
  - When sterilizing wrapped instruments it is recommended that a pouch rack such as the **Tuttnauer™ Pouch Rack**

be used to ensure proper steam penetration and adequate drying when sterilizing pouched instruments.

- If a pouch rack is not available then the pouches need to be laid out plastic side UP and only one layer deep on each tray.
- When sterilizing cassettes in the EZ9Plus the cassettes are loaded horizontally (see picture below).



- When sterilizing cassettes in the EZ11Plus they are loaded vertically (see picture below). To adjust the rack for vertical sterilization of cassettes, remove the trays and gently squeeze the sides of the rack inward and at the same time rotate the rack into a vertical position.
- When sterilizing textiles do not put the textiles on the bottom tray.



2. Ensure that the correct sterilization program is selected:
  - Use the **UP** or **DOWN** keys to select the program to run.
  - The program can only be changed when the door is open.
3. If needed additional drying time can be added at this time (see sec. 7.1.1).

4. Close the door by either:
  - Holding the handle in the open position while pushing the door until it comes to the closed position, then releasing the handle.
  - Pushing on the door handle and gently pushing the door closed.
  - When the door is properly closed the open door symbol  is then replaced by the message “**System Ready**”.
5. Start the cycle by pressing the **START/STOP** key.

### ***Loading of heavy and diverse loads***

When sterilizing heavy loads we recommend using a **Tuttnauer™ Pouch Rack**. See the figures below showing examples of using a combination of trays and racks for sterilizing heavy or diverse loads. The EZ9Plus is supplied with 3 wire trays. The EZ11Plus is supplied with 5 wire trays and 1 pouch rack.

NOTE: The EZ9Plus can accommodate 1 pouch rack and the EZ11Plus can accommodate 2 pouch racks.

**EZ9Plus**



**EZ11Plus**



## **Cycle Description**

- The door is now locked
- “Water Filling” is displayed until the correct volume of water has automatically filled the chamber.
- The autoclave starts performing the sequence of operations. The actual measured values of pressure and temperature are displayed continuously and printed (if the optional printer is installed).
- The EZView display shows the current stage of the cycle. (See sec. 5.1 ).
- In any program that has a drying stage scheduled, the dry stage begins after the steam exhaust stage. The autoclave is equipped with an air pump that during the drying stage draws air through a HEPA filter (0.2 µm) and circulates that air through the heated chamber and out the slow exhaust valve to remove moisture and facilitate the drying operation. Drying is performed with the door closed.
- At the end of a successful cycle, the screen shows the Cycle Ended message and the door is automatically unlocked. The slow exhaust valve is opened to prevent formation of a vacuum.
- In the event of a program failure, the exhaust valve is opened to release pressure from the chamber and a fail message is displayed.
- There is a mandatory 1 minute of drying before the door can be opened.
- When the mandatory drying is completed pressing the **START/STOP** key will clear the error message and unlock the door.



### **11.6. Unloading**

When the cycle has ended successfully, the message “Cycle Ended” is displayed and the door is automatically unlocked.

The door can be opened and the load removed.

#### **WARNING!**

**To avoid severe injuries from hot steam when opening the door:**

- ***It is strictly forbidden to lean on the autoclave.***
- ***It is strictly forbidden to place your hand or any part of your body over the door.***





Use the tray handle or wear heat-resistant gloves to remove the load from the autoclave.

On completion of the cycle, the load shall be visually inspected to ascertain that the load is dry, and that sterilization indicators have made the required color change.



**WARNING!**

***The sterility of the instruments processed in unwrapped cycles cannot be maintained if exposed to non-sterile environment.***

If the symbol for “Water in the Chamber”  appears on the screen, **The door will stay locked.** This indicates that there is still water in the chamber or that the water electrode, in the chamber, needs to be cleaned. To open the door, see Emergency Door Opening section 12.8

**CAUTION! Bypassing the automatic door lock and forcing the door open can result in water spilling out of the chamber.**

### ***11.7. Stopping the process manually***

It is possible to stop the program while the autoclave is operating. Pressing the **START/STOP** key at any stage of the process stops the operation. Any cycle that stops prematurely is considered a failed cycle.

***WARNING! If the cycle was aborted before completing the sterilization stage, it will leave the load unsterilized. Handle it as a contaminated load.***



- If the cycle is manually aborted **before** completing the sterilization stage, the screen becomes yellow; a caution symbol is displayed with the message "Cycle Failed" and an error message stating the reason for the failure. (See sec. 5.3).

If the cycle is manually aborted **after** the sterilization stage is completed, the screen will remain white with the message “Cycle Ended” and a second message stating the reason for the failure. (See sec. 5.2.1 )

- There is a mandatory 1 minute of drying before the door can be opened.
- When the mandatory drying is completed pressing the **START/STOP** key cancels the displayed message and unlocks the door so it can be opened.

- If the symbol for “Water in the Chamber”  appears on the screen, **The door will stay locked.** This indicates that there is still water in the chamber or that the water electrode, in the chamber, needs to be cleaned. To open the door, see Emergency Door Opening section 12.8

**CAUTION! Bypassing the automatic door lock and forcing the door open can result in water spilling out of the chamber.**

### 11.8. Stopping the process due to cycle failure

- The cycle can stop itself if the unit detects a problem.

**WARNING! If the cycle was aborted before completing the sterilization stage, it will leave the load unsterilized. Handle it as a contaminated load.**



If the cycle is aborted **before** completing the sterilization stage, the screen becomes yellow; a caution symbol is displayed with, the message "Cycle Failed", and an error message stating the reason for the failure. (See sec. 5.3 )

- If the cycle is aborted **after** the sterilization stage is completed, the screen will remain white with the message “Cycle Ended” and a second message stating the reason for the failure. (See sec. 5.2.1 ).
- There is a mandatory 1 minute of drying before the door can be opened.
- When the mandatory drying is completed pressing the **START/STOP** key cancels the displayed message and unlocks the door so it can be opened.



• If the symbol for “Water in the Chamber”  appears on the screen, **The door will stay locked.** This indicates that there is still water in the chamber or that the water electrode, in the chamber, needs to be cleaned. To open the door, see Emergency Door Opening section 12.8



**CAUTION! Bypassing the automatic door lock and forcing the door open can result in water spilling out of the chamber.**

## **12. MAINTENANCE INSTRUCTIONS**

### **12.1. Preventive and Scheduled Maintenance**

The maintenance operations described in this chapter need to be followed as indicated to keep the device in good working condition. This maintenance schedule is the responsibility of the equipment owner and not covered under the warranty.

The majority of instructions that follow can easily be carried out by the operating personnel and do not require a service technician.

Should the need arise or the instructions in this section indicate, technical assistance or a service technician can be requested by either calling your dealer or Tuttnauer USA.

#### **12.1.1. Daily**

- Clean the door gasket and outside rim of the chamber with a mild detergent, water and a soft cloth or sponge. The gasket should be clean and smooth. Be sure to clean the inside and outside of the gasket flap.

#### **12.1.2. Weekly by the operator**

- Once per week or after 20 cycles, clean and descale the chamber, copper tubes and the reservoir using **Chamber Brite™**. Follow these instructions:

#### ***Cleaning Table Top Autoclaves with Chamber Brite™***

**CHAMBER BRITE™** is a cleaning and descaling agent designed specifically for the cleaning and removal of water deposits, oxides and other sediments that are found in steam sterilizers. The material is a combination of acidic salts and additional cleaning materials.

Cleaning is an important part of maintaining your sterilizer.

Cleaning the autoclave chamber is a very simple, but important procedure to keep your sterilizer operating properly.

If the autoclave is not cleaned regularly, dirt and debris will build up and clog the tubing and valves.

This dirt can also be transmitted to the instruments during sterilization.

In addition, a layer of dirt on the stainless steel chamber traps moisture against the metal and will lead to the chamber becoming porous and failing.

## Cleaning Procedure

Items you will need to have on hand:

Chamber Brite™

- For EZ9Plus models use one packet of CHAMBER BRITE™.
- For EZ11Plus models use one packet of CHAMBER BRITE™.

Soft cloth or sponge

Drain hose (to drain water reservoir)

Pail (to drain reservoir water into)

Gloves

Nonabrasive stainless steel cleaner (for trays and tray rack)

Steam distilled water **having the characteristics described in sec. 3.8.**



### Important!

**Please remember:**

**NEVER use bleach, steel wool, a steel brush or anything abrasive to scrub or clean the chamber, trays and tray holder.**

**Do NOT sterilize instruments during the chamber cleaning process.**

**Before using Chamber Brite, the autoclave chamber MUST be cold. If the chamber is hot, Chamber Brite will react and give off an odor.**

**All steps in this procedure must be completed without interruption.**

1. When the autoclave chamber is cold, remove instruments trays and the tray holder from the autoclave. Starting with a hot chamber can result in burning of the Chamber Brite and the release of a strong odor.
2. Open the door and spread the contents of one packet of Chamber Brite™ in a straight even line along the bottom of the chamber, from back to front. Avoid leaving a pile of Chamber Brite in one spot.
3. Select the *Chamber Brite* program, Close the door and start the cycle.
4. At the end of the cycle open the door and drain the water from the reservoir
5. Fill the reservoir with steam distilled water or mineral free water only. **Use only water having the characteristics described in sec. 3.8.**

- 6 Repeat the Chamber Brite cleaning cycle, BUT without using the Chamber Brite powder. This will remove any residue from the internal plumbing.
7. At the end of the second cycle open the door and drain the water from the reservoir.
8. Wipe the interior of the chamber with a damp cloth or sponge to remove any residue.  
  
Clean the water sensor in the rear of the chamber with a damp cloth or sponge. Cleaning the dirt off the sides of the sensor is more important than the tip. (see sec. 12.6 )
9. Fill the reservoir with steam distilled water or mineral free water only. **Use only water having the characteristics described in sec. 3.8.**
10. The autoclave is now ready to use.

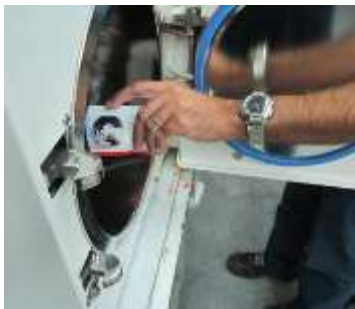

**IMPORTANT:**  
**DO NOT sterilize instruments during the cleaning process!!!**  
**CAUTION!**

- **Keep out of reach of children. Contains mildly acidic ingredients. Avoid contact with the skin, eyes or clothing. Wash hands well after touching the powder, in the case of eye contact flush with continuous running water for at least 15 minutes. If irritation persists get medical attention.** If large quantities of this material are swallowed, call a physician immediately. Do not induce vomiting unless directed to do so by medical personnel. Never give anything by mouth to an

unconscious person. If victim is conscious give water to drink.

**Note:** If cleaning the chamber with Chamber Brite is not possible then at a minimum follow these two steps.

1. Once per week, drain the reservoir (see sec. 12.2) and fill with steam distilled water or mineral free water only. Use only water having the characteristics described in sec. 3.8.
  2. Clean the water sensor in the rear of the chamber with a damp cloth or sponge. Cleaning the dirt off the sides of the sensor is more important than the tip. (see sec. 12.6).
- Clean the tray holder and trays with a non-abrasive stainless steel cleaner and water, using a cloth or sponge. You may use diluted Chamber Brite™ solution as cleaning agent. To prepare this solution, pour one packet of Chamber Brite™ into 32 ounces of warm mineral-free water. Rinse the tray holder and trays immediately after cleaning with clean water to avoid staining the metal. Wipe dry with a cloth or paper towel.

**CAUTION!**

**Do not use steel wool, steel brushes, bleach or any cleaning agent containing bleach or anything abrasive to clean the chamber, tray holder or trays. Doing so will damage the chamber and trays!**



- Put 1-2 drops of oil, such as 3 IN ONE Oil, on the door pins and any moving parts of the door locking mechanism (See the figure below).

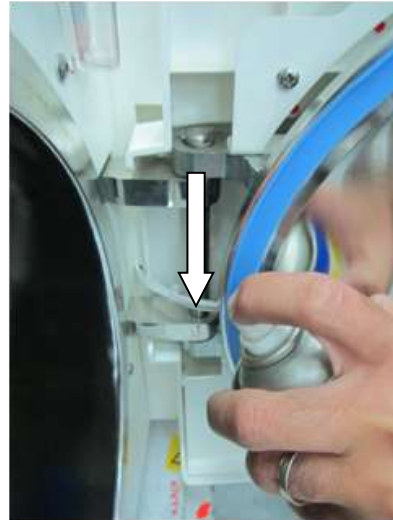
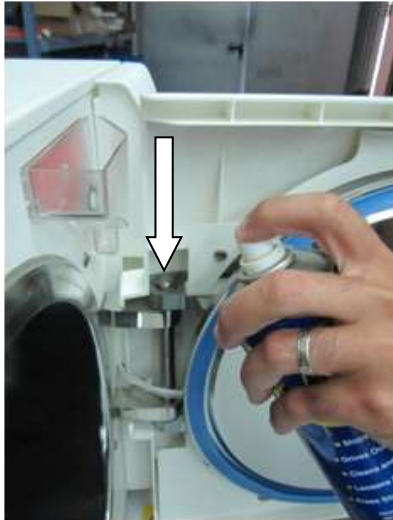

- Clean the outer parts of the autoclave with a soft cloth.

### **12.1.3. Periodically**

- Once a month, check the safety valve (see sec. 12.4).
- Once per month clean the water outlet strainer as per sec. 12.5. Cleaning frequency may be reduced according to experience.
- Check the door gasket every 12 months, for cracks or damage and replace it if there is tear or leakage.
- (see sec. 12.3).
- Replace the HEPA filter, every 6 months or after 1000 cycles (whichever is the shorter period), see sec. 12.7.

The following operations should be done by an authorized Tuttnauer service technician.

### Once a year

- Check the continuity of the grounding connections.
- Perform validation of the autoclave as needed.
- Check the precise operation of the earth leakage relay.
- Check that the autoclave is on a sturdy counter top and all the autoclave feet are present and properly adjusted.
- Check the safety elements; safety valve, cut-off thermostat and door locking mechanisms are functioning properly.
- Check the overall operation of the autoclave.
- Check the water reservoir, piping, plastic parts and electric wires are clean and in good condition.
- Check and tighten the piping joints to avoid leakage.
- Check and tighten all connections in the control box, heaters and valves and instrumentation.
- Check for dust build up on fan or in the electronic box.

### Once in 5 years -

- Check the door and door locking mechanism for excessive wear.
- Perform safety tests: pressure vessel, efficiency, electrical, according to local rules or regulations.

### 12.2. Draining the Reservoir



#### **CAUTION!**

**Before starting, make sure there is no pressure in the autoclave.**

The drain valve is located on the front right side of the autoclave after the door is opened (1). The function of the drain valve is to drain the water reservoir.

1. Open the door
2. Turn off the main power switch
3. To drain the reservoir, use item (5) with the plastic hose (6) attached to it (supplied with the autoclave).



4. Insert part (5) into valve (3) and press it in until you hear a click. The drain valve opens immediately, drain into a bucket.
  5. When the water reservoir is empty, press part (4), in an upward direction. Item (5) will be released and pop out approx. 3mm and the drain valve will be closed. Remove item (5) with the plastic tube.
  6. When you are ready, fill the reservoir with steam distilled water having the characteristics described in sec. 3.8 until it reaches the full level.
  7. Turn on the main power switch.
- The autoclave is now ready for use.

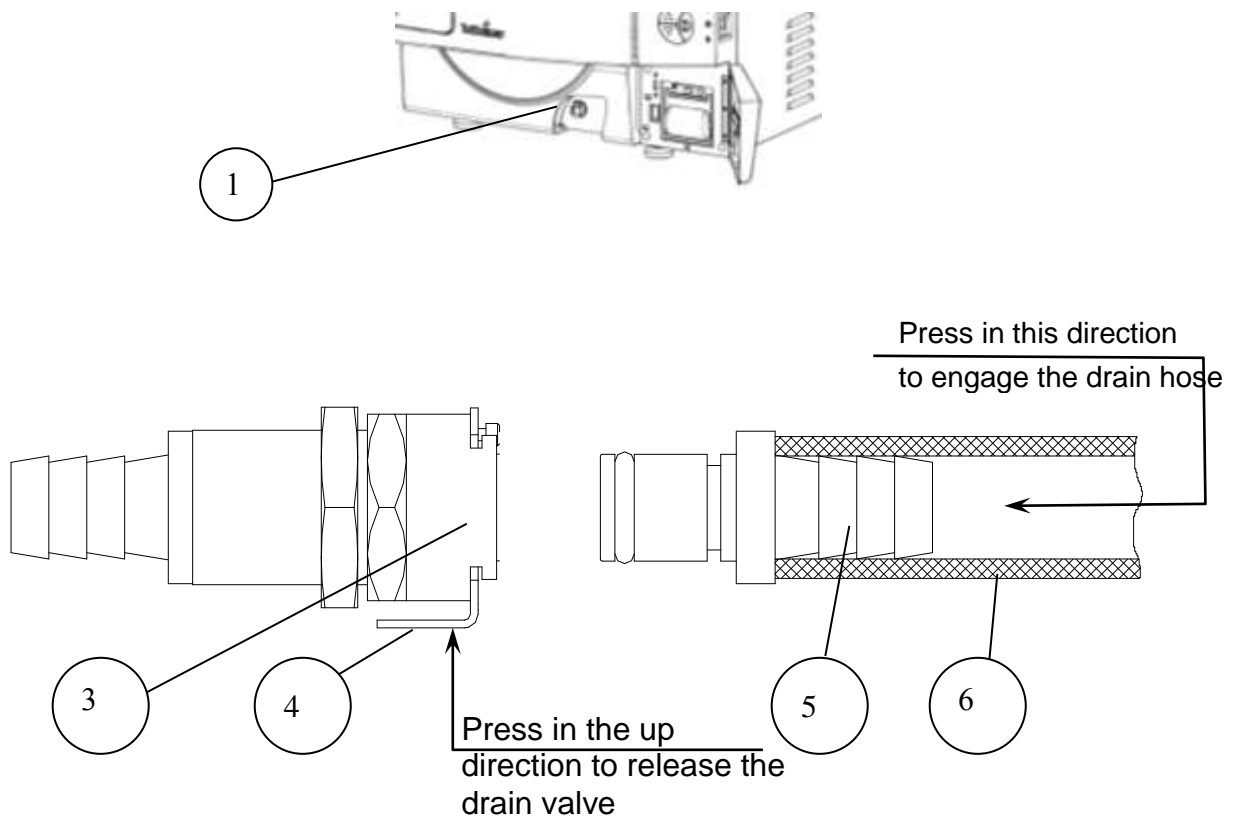

### 12.3. Replacing the Door Gasket



**To avoid injuries replace the gasket while the autoclave and autoclave door are cold.**

Pull off the gasket from the door groove and install the new gasket referring to the directions below.

1. Pull off the gasket from the groove.



2. Clean the groove of any remnants of the old gasket (use a plastic scraper and plain water as needed).



3. Line the inside of both sides/walls of the gasket groove with a small amount of silicon lubricant. This can be sprayed in or brushed in depending on the type lubricant you use. Make sure to fully coat the inside of the groove.



**Note:** It is necessary to use a silicone based lubricant such as Würth Silicone Lubricant or Dow Corning 111, when installing the door gasket.



**CAUTION!** If insufficient lubricant is applied - replacing the gasket will be difficult. If excess lubricant is applied, the gasket will 'spring' out of the groove.

Place the gasket inside the groove and press it in with a finger or a tool using one continuous movement all the way around the groove.



**CAUTION!** Make sure the gasket sits evenly without waves, humps, or cavities. If the door gasket is not perfectly smooth it will not seal the chamber properly. This drawing shows the correct direction of the gasket.



Gasket

Door

---

## 12.4. Checking the Safety Valve

(Located in the water reservoir)

In order to prevent the safety valve from becoming blocked, it is necessary to open the valve under pressure. This will allow the steam to escape clearing the seat of the valve. Once per month, perform the following procedure:

1. Operate the sterilization cycle according to the manual, but with no instruments.
2. Allow a pressure of approximately 29 Psig (300KPA) to build up in the chamber.
3. Remove water reservoir cover (1).



### CAUTION!

**The next step will expose you to hot steam. To avoid being burned by hot steam, keep all body parts away from the steam flow.**

1. Pull the ring of the safety valve using a tool, i.e. screwdriver, hook etc. and open the safety valve ring for 2 seconds, and then release it. Be careful not to burn your hands.
2. After 2-3 seconds the safety valve should close automatically.
3. Press the **START/STOP** key to abort the cycle, and allow the steam to exhaust from chamber.
4. Wait until the pressure goes down to zero, only then can the door be opened.
5. If the safety valve closes properly the procedure was successful.
6. If the safety valve does not close or leaks steam or water when it does close the safety valve needs to be replaced. This will require an authorized service technician.

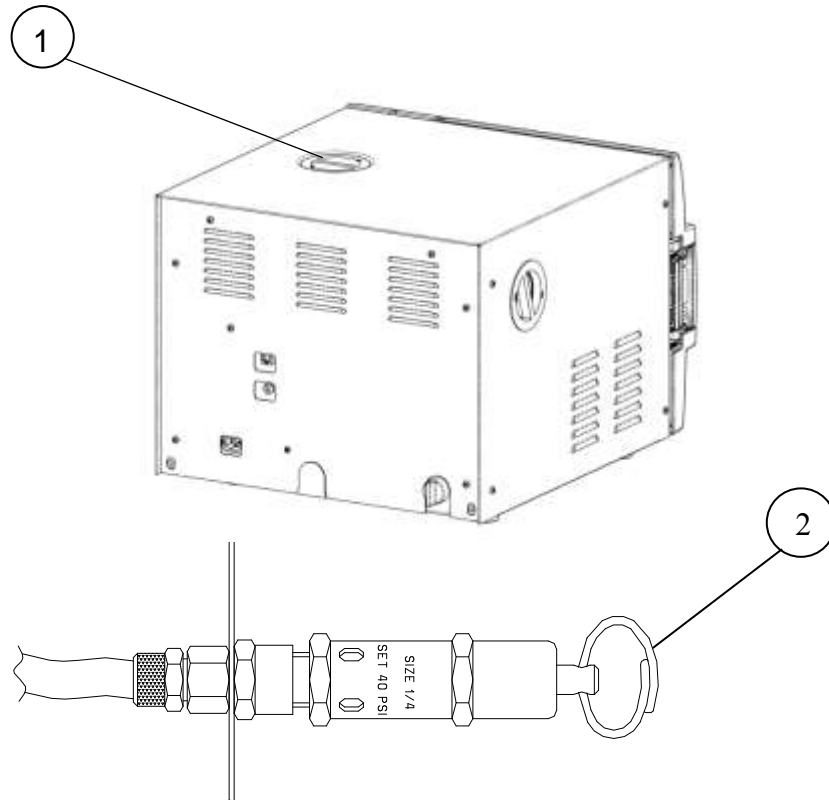

### 12.5. Cleaning the water outlet strainer



#### **CAUTION!**

Before proceeding, Make sure that the electric cord is disconnected and there is no pressure or water in the chamber.



#### **WARNINGS!**

##### **1. The strainer's cover can be HOT**

**Do not touch the strainer's cap during and shortly after having run a cycle. The outlet strainer is in direct contact with the chambers exhaust line and can be very hot. Touching the hot strainer's cap may cause severe injuries.**

**2. If this maintenance operation must be performed while strainer cap is hot, use heat resistant gloves to avoid injuries.**

1. Unscrew the water outlet strainer cap (1) from the strainer housing (2).
2. Take out the gasket (3) and the trainer element (4).
3. Rinse with water and clean the strainer, with a brush if necessary.
4. Reinstall the gasket and strainer element into the cap.
5. Make sure the gasket is seated properly.
6. Reinstall and tighten the strainer cap

**Note:** Tighten the cap by hand, until tight.

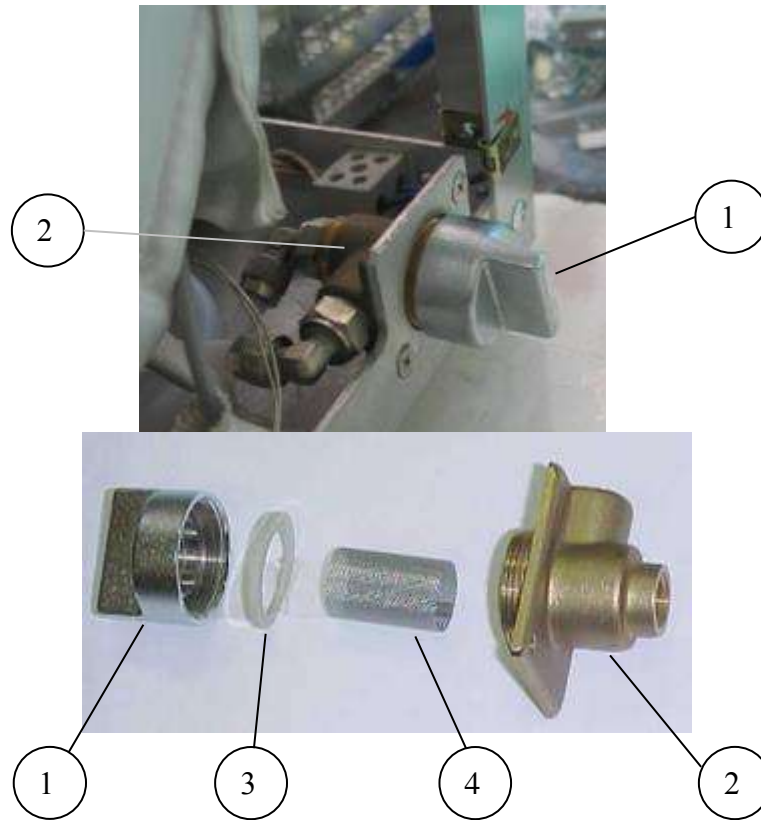

	<b>Description</b>	<b>Cat. No.</b>
1	Cap for ¼" strainer	FIL175-0027
2	Strainer Housing + Cap	FIL175-0071
3	Teflon gasket 4 mm	GAS082-0008
4	Strainer element	FIL175-0046

## 12.6. Water Sensor Cleaning

It is required that the water sensor be cleaned at least once per week. Cleaning the sensor will ensure that the water level in the chamber is properly reported to the microprocessor all during the cycle.

The water sensor is located in the rear of the chamber, on the bottom right side. It is easily cleaned using a damp cloth or sponge; you may use a mild soapy solution if you like. It is important to wipe the sides of the sensor as well as the tip, to remove any dirt or debris that may have built up.

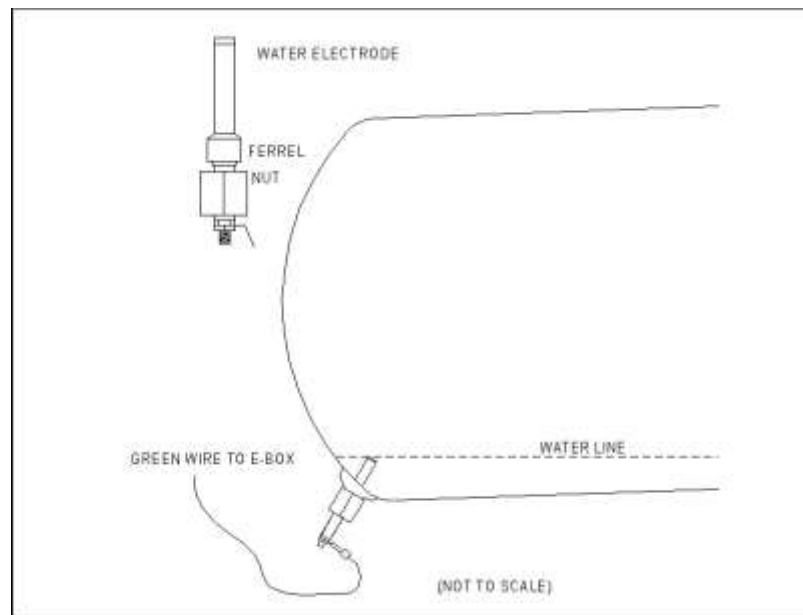

## 12.7. Replacing the HEPA Air Filter



### **CAUTION!**

**Before proceeding, make sure that the electric cord is disconnected and there is no pressure in the autoclave.**

To facilitate drying the instruments with the door of the chamber closed, the EZ9Plus and EZ11Plus are equipped with an air pump and HEPA filter (0.2 $\mu$ m). During the drying stage the pump draws air through the HEPA filter and circulates that air through the heated chamber. This is designed to remove moisture from the wrapped instruments. A bacteriological HEPA filter is used to ensure that only highly filtered air is allowed into the sterile chamber.

**Note:** It is recommended to replace the HEPA filter, every 6 months or after 1000 cycles (whichever is the shorter period). Surrounding conditions can make it necessary to replace the filter after a shorter interval of time.

**If the drying time is taking longer than normal this can be an indication of a clogged filter.**

The HEPA filter is located on the left side of the autoclave, this is to allow easy access for replacing it (See Rear View (7) at the beginning of this manual).

To replace the filter proceed as follows:

1. Pull out the filter cover. The filter cover is held in place by plastic tabs. Rotate the cover until the tabs release, the cover will come off and the filter will come out.
2. Disconnect the filter from the flexible tube.
3. The filter and cover are pressed together. Place two fingers between the filter and the cover and while supporting the cover pull the filter and cover apart.
4. Insert a new filter into the filter cover by pressing it into the filter seat. Make sure that the arrow on the filter body, which indicates the direction of air flow, points away from the filter cover.
5. Reconnect the flexible tube.
6. Replace the filter and cover by inserting and rotating it  $\frac{1}{4}$  of a turn.

**Note:** Make sure that you don't bend the flexible tubing, in a way that will restrict the flow of air, when reinstalling the filter and reattaching the cover to the machine.





## 12.8. Emergency door opening.

If there is no power to the autoclave and the door is closed the lock will be engaged. If you need to open the door, follow this procedure:



### Warning!

**Before opening the door, make sure that the autoclave is cold and there is no pressure in the chamber!**

### 12.8.1. Relieve pressure from inside the chamber

Since the autoclave is not equipped with an analog pressure gauge, and the display is off (no electrical power), it is recommended to wait approximately two hours since the shutdown to verify that the pressure and temperature have decreased to ambient conditions.

If it is necessary to open the door immediately, then follow these instructions to relieve the chamber pressure by opening the safety valve. The safety valve is located in the mineral-free water reservoir.

1. Turn off the power switch and unplug the unit.
2. Remove water reservoir cover (See Front View (4) at the beginning of this manual).
3. Pull the ring (3) of the safety valve using a tool, i.e. screwdriver, hook etc. (2). Pull the safety valve ring until steam ceases to escape from the safety valve. Be careful not to burn your hands.

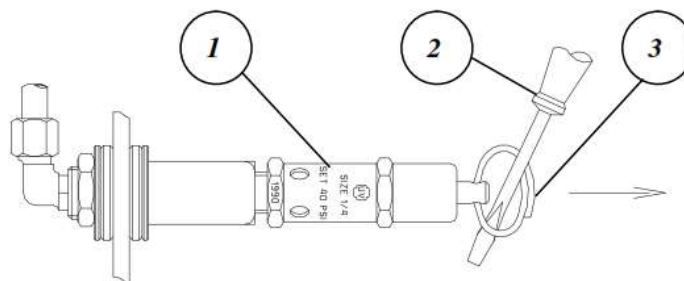

No.	Description
1	Safety valve
2	Pulling device
3	Pressure relief ring

**Warning!**

After relieving any residual pressure use caution when opening the door as left over water may spill out.



**12.8.2. Opening the door**



**Caution! This option is for emergency cases only! Before opening the door, always make sure that there is no pressure in the chamber and the electric cord is disconnected (See above).**

1. Insert a 2 mm (0.08") pin (1) into the hole (2) located above the door opening handle (3).
2. Press the pin downwards and, simultaneously open the door by pulling the door handle (3) in the direction of the arrow (4).
3. When the door handle starts to open remove the pin and finish opening the handle.



**CAUTION!**

If there is water in the chamber it will spill out when the door is open.

### 13. TROUBLESHOOTING

This troubleshooting chart enables the user to solve minor malfunctions, prior to requesting service. Only technical personnel having proper qualifications and holding technical documentation (including a technician manual) and adequate information are authorized to service the apparatus.



For technical assistance call your dealer or Tuttnauer USA

<b>Problem/ Error Message</b>	<b>Problem Description</b>	<b>Corrective Action</b>
Door will not open	Sleep mode is active and the screen saver is displayed	Awaken the unit from the sleep mode by pressing the START/STOP key.
	There is water in the chamber and the water in the chamber icon  is displayed	Start a new cycle. At the end of the new cycle water will be returned to the reservoir.
	The power is turned off.	Turn power on
	The machine has not returned to normal pressure	Wait for the machine to return to normal pressure.
	An error message is displayed	Press the START/STOP key to clear the error message and unlock the door.
Display does not turn on	The main switch is in the off position.	Turn the main switch on.
	The power cord is not connected properly to the machine and the power source.	Make sure the power cord is properly connected to the machine and the power source.
	The cut-out thermostat has tripped.	Press in the reset button on the cut-out thermostat, (see rear view drawing at the front of this manual).
	There is no electrical power in the main source.	Fix the electrical power supply.

Problem/ Error Message	Problem Description	Corrective Action
The printer does not print	The paper is not inserted correctly in the printer.	Make sure the paper is inserted in the printer correctly. See sec. 8.2 . Switch the machine off then back on. If the printer prints the date and time, the printer is O.K.
"Analog Input Error"	This message is displayed when any Temperature sensor or Pressure sensor is disconnected or out of range.	Turn the unit off and then back on. If the message reappears call for service.
"Chamber temperature not in range"	This message is displayed if the temperature in the chamber is higher or lower than the normal range.	Wait until the chamber reaches the normal temperature range If this takes more than 5 minutes call for service.
"Chamber pressure not in range"	This message is displayed if the pressure in the chamber is higher or lower than the normal range.	Wait until the chamber reaches the normal pressure range. The atmospheric pressure parameter may need to be set. See section 7.2.4.2 .
"I/O Card Failed"	This message is displayed if I/O card is faulty	Turn the unit off and then back on. If the message reappears call for service
"I/O card is not connected"	This message is displayed if the main control board has lost communication with the I/O card.	Turn the unit off and then back on. If the message reappears call for service
"Low Temp"	This message is displayed if the temperature drops below the sterilization temperature for more than 1 second during the sterilization cycle.	Perform a new cycle. The chamber may be overloaded, remove some material from the chamber. Check for steam leakage around the door. Clean or replace the door gasket if necessary. If the problem persists, call for service.
"High Temp"	This message is displayed if the temperature raises 5.4°F (3°C) above sterilization temperature for 2 seconds during the sterilization cycle.	Perform a new cycle. If the problem persists call for service.

Problem/ Error Message	Problem Description	Corrective Action
"High Temp. (Ending)"	This message is displayed if the chamber cannot reach the required ending temperature within 10 minutes.	Verify that the autoclave is not overloaded. Remove some material from the chamber Perform a new cycle. If the problem persists call for service.
"Heat Time Error"	This message is displayed if the chamber cannot reach the required temperature within the preset time.	Perform a new cycle. The chamber may be overloaded, remove some material from the chamber. If the problem persists call for service.
"Heat Time Error (Keep)"	This message is displayed if the system cannot reach the required temperature, in the chamber, during the optional "Keep Heat" stage, within the preset time.	Perform a new cycle. The chamber may be overloaded, remove some material from the chamber. If the problem persists call for service.
"Low Pressure"	This message is displayed if Chamber Pressure drops below the sterilization pressure for 2 seconds during the sterilization stage.	Perform a new cycle. The chamber may be overloaded, remove some material from the chamber. Check for steam leakage around the door. Clean or replace the door gasket if necessary. If the problem persists call for service.
"High Pressure"	This message is displayed if Chamber Pressure raises 4.2 psi (29 kPa) above sterilization pressure for 2 seconds during the sterilization stage.	Perform a new cycle. If the problem persists call for service.
"High Pressure (Ending)"	This message is displayed if the system cannot reach atmospheric pressure $\pm$ 0.74psi (5kPa) during the ending stage.	Reset the atmospheric pressure. Call for service
"High Pressure (Exhaust)"	This message is displayed if the system cannot reach preset pressure within 10 minutes from the beginning of the exhaust stage.	Reset the atmospheric pressure. Call for service
"High Pressure (Dry)"	This message is displayed if the pressure in chamber exceeds atmospheric pressure by more than 1.5psi (10kPa) at the beginning of the dry stage.	Reset the atmospheric pressure. Call for service

Problem/ Error Message	Problem Description	Corrective Action
"Pressure Time Error"	This message is displayed if the system cannot reach the required pressure conditions in the chamber, after preset time, during the air removal stage.	Perform a new cycle. The chamber may be overloaded, remove some material from the chamber. If the problem persists call for service.
"RTC Error - Please Set Current Date and Time"	This message is displayed if the date and time need to be set.	Set current Date And Time. See sec. 7.1.6 If the problem persists, call for service.
"Time Error"	The Date and Time have not been set.	Set current Date And Time. See sec. 7.1.6
	This message is displayed if the real time clock is faulty.	Call for service.
"Door is open (During the cycle)"	This message is displayed during the cycle. if the door is open or the door switch is faulty.	Close the door more forcefully and perform a new cycle. If the problem persists call for service.
"Canceled By User"	This message is displayed any time the START/STOP key is pressed after the cycle has started, the cycle will be aborted.	Wait until "cycle failed – canceled by user" or "cycle end – canceled by user" is displayed. Press the START/STOP key to clear the error message and perform a new cycle.
 "Cycle Failed"	This message and symbol are displayed if an error occurs before sterilization cycle is completed.	Press the START/STOP key to clear the error message then perform a new cycle. If the problem persists call for service.
"Air Error"	This message is displayed at the end of the cycle if the autoclave does not reach the atmospheric pressure after 10 minutes.	Wait until the autoclave reaches the atmospheric pressure. Reset the atmospheric pressure. If the problem does not correct itself call for service
"Mineral free water reservoir empty"	This message is displayed if the water level electrode does not sense water.	Fill the mineral free water reservoir. If the reservoir is full then turn the unit off and back on.

Problem/ Error Message	Problem Description	Corrective Action
	The water level electrode is faulty.	Call for service
"Power Down"	This message is displayed if power down has occurred during the cycle. (If a printer is installed the message will print "Power Down" when power is restored).	Check that the On/Off switch is not off Check that the power cord is plugged into the wall outlet and the back of the machine Check that there is power at the wall outlet. Perform a new cycle when power is restored.
"No Water in the Chamber"	This message is displayed if the electrode in the chamber does not sense water, at the beginning of the cycle, within the preset water filling time.	1.Fill the reservoir with steam distilled water. 2. Clean the water level electrode. 3. If this does not help, call for service
	This icon is displayed when the reservoir needs water.	Fill the reservoir with distilled water
	This icon is displayed if the electrode senses water in the chamber after the cycle has stopped. The door will remain locked.	DO NOT open the door, water will spill out. Run a new cycle to drain the chamber. The water electrode may be dirty giving a false reading, clean the electrode.
Door gasket makes a high pitched whistle	Door is not closed properly.	Open door and close it more forcefully.
	Door gasket is dirty.	Clean the door gasket.
	Door gasket needs to be replaced.	Replace door gasket using silicone lubricant.
	Lubricant was not used properly when door gasket was replaced.	Remove gasket and clean off excess lubricant. Reinstall using proper amount of lubricant.

<b>Problem/ Error Message</b>	<b>Problem Description</b>	<b>Corrective Action</b>
Water under the sterilizer	Reservoir is over filled. The reservoir has an overflow and excess water in the reservoir will drain through the overflow on to the counter below the sterilizer.	Don't fill while a cycle is running. Don't fill above the blue area on the Front Fill Funnel. If the reservoir is overfilled drain excess water by using the front drain.



***POUCH RACK AR910***



***TRAY HANDLE CMT240-0097***



***TRAY TRY254-0003***



***TRAY HOLDER FOR EZ9PLUS, TRH234-0001***



**TRAY HOLDER FOR EZ11PLUS TRH411-0021**

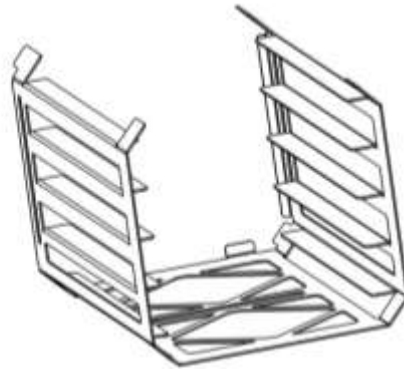

**14. SPARE PARTS LIST**

Description	Part number
Filter, Air, 0.2 Micron	FIL175-0066
Printer paper 5 pack	THE002-0003

**15. ACCESSORIES**

Description	Part number
Pouch rack EZ9Plus, EZ11Plus	AR910
Handle, Tray	CMT240-0097
Drain silicone Tube, 7x13	GAS083-0004
Drain connecter male	VLV170-0014
Printer, PLUSII-S2B-0004	THE002-0052
Holder, Tray EZ9Plus	TRH234-0001
Holder, Tray EZ11Plus	TRH411-0021
120 volt US power cable	WIR040-0004
Tray	TRY254-0003